









FRESE PER BALCONI PERLINE E PAVIMENTI

-  - BALCONY TONGUE AND GROOVE CUTTERS
-  - FRAISES POUR BALCON À RAINURE ET LANGUETTE
-  - NUT-FEDER AUSSENBAALKON GARNITUREN
-  - JUEGO DE FRESAS PARA BALCÓN PARA MACHIHEMBRADOS

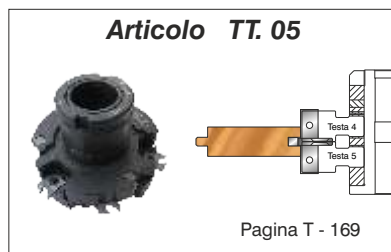
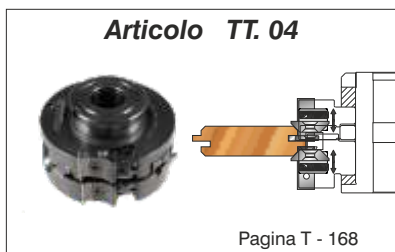
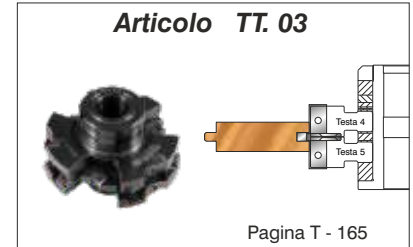
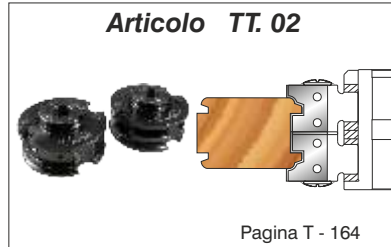
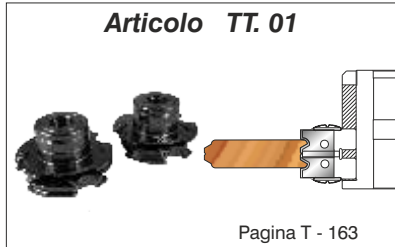
TT



GRUPPI FRESE PER GIUNZIONI PER BALCONI ESTERNI

-  - GROUPS OF CUTTERS FOR JOINTS FOR OUTSIDE BALCONY
-  - GROUPES DE FRAISES POUR ASSEMBLAGES POUR BALCON EXTÉRIEUR
-  - VERBINDUNGS FRAESERGRUPPE FUER AUSSENBAKONE
-  - GRUPO DE FRESAS PARA ENSAMBLES PARA BALCÓN EXTERIOR

TT.01

Ø	n.min.	n.max.
135		9000
145		8700

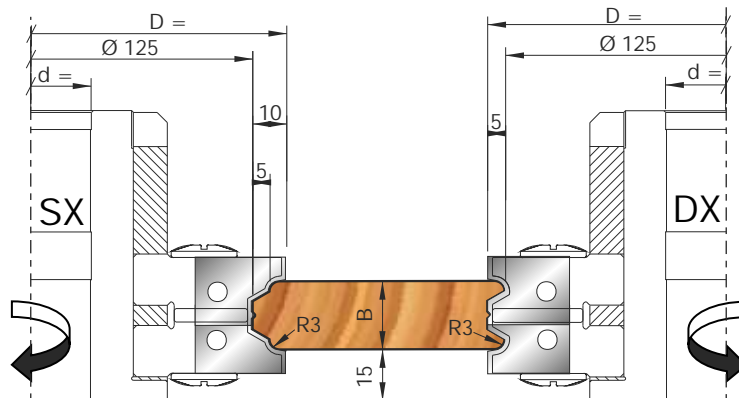
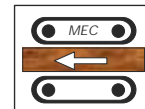
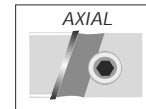

Articolo	D	B	d	Z	↶	↷	Prezzo
TT. 01.01	135	20	30/35/40/50	2		DX	S 52
TT. 01.02	145	20	30/35/40/50	2	SX		S 53

NB: d=50 (Senza mozzo/Without sleeve/Sin casquillo/Ohne Spannbuchse/Sans manchon)

RICAMBI-SPARE PARTS-RECHANGES-ERSATZTEILE-RECAMBIOS

Articolo	Descrizione	Dimensione	Prezzo
CU. 04330PD01	 Cuneo / Wedge	20x25x10 DX	H9
CU. 04330PS01	 Cuneo / Wedge	20x25x10 SX	H9
CU. 04329PD02	 Cuneo / Wedge	20x30x10 DX	H9
CU. 04329PS02	 Cuneo / Wedge	20x30x10 SX	H9
VU. DS.03	 Vite / Screw	M8x22	A45
VU. OP01	 Ogiva / Nut	M8	A47
SC. CM.03	 Chiave / Allen Key	B4	A27

La rotazione standard è prevista per macchina scorricatrice. A richiesta versione per toupie.

The tools are supplied for standard rotation used on moulding machines. On request toupie version.



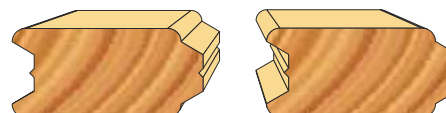
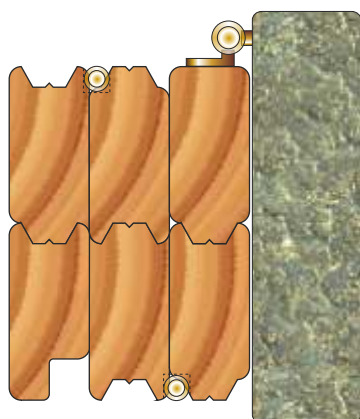

Les sens de rotation standard est prevue pour machines pour moulurières. Tranchants commandés version pour toupie.

Die Standard Drehrichtung ist für mehrspindelige Kehlmaschinen vorgesehen. Auf wunsch ausführung für toupie.

La rotación standard está prevista haciendo de guaa la parte de la ranura. Sobre demanda version para toupie.



GRUPPI FRESE PER GIUNZIONI PER BALCONI ESTERNI

-  - GROUPS OF CUTTERS FOR JOINTS FOR OUTSIDE BALCONY
-  - GROUPES DE FRAISES POUR ASSEMBLAGES POUR BALCON EXTÉRIEUR
-  - VERBINDUNGS FRAESERGRUPPE FUER AUSSENBAKONE
-  - GRUPO DE FRESAS PARA ENSAMBLES PARA BALCÓN EXTERIOR

TT.02

Ø	n.min.	n.max.
147		8600

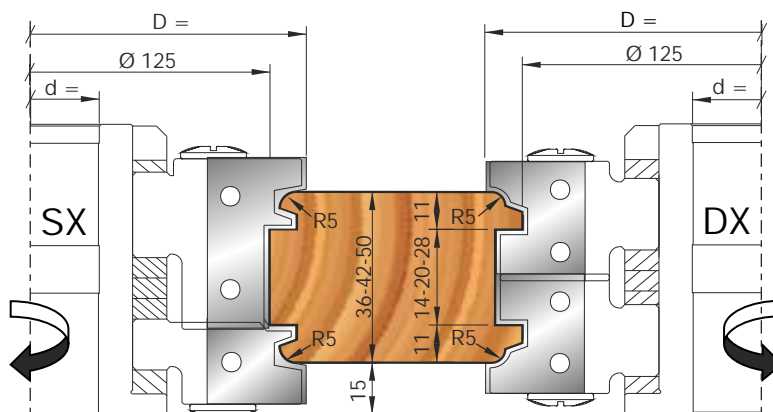
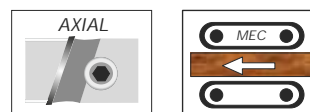

Articolo	D	B	d	Z	↶	↷	Prezzo
TT. 02.01	147	50	30/35/40/50	2		DX	S 54
TT. 02.02	147	50	30/35/40/50	2	SX		S 55

NB: d=50 (Senza mozzo/Without sleeve/Sin casquillo/Ohne Spannbuchse/Sans manchon)

La rotazione standard è prevista per macchina scorniciatrice. A richiesta versione per toupie.



The tools are supplied for standard rotation used on moulding machines. On request toupie version.

Les sens de rotation standard est prevue pour machines pour moulurières. Tranchants commandés version pour toupie.

Die Standard Drehrichtung ist für mehrspindelige Kehlmaschinen vorgesehen. Auf wunsch ausführung für toupie.

La rotación standard está prevista haciendo de guaia la parte de la ranura. Sobre demanda version para toupie.

RICAMBI-SPARE PARTS-RECHANGES-ERSATZTEILE-RECAMBIOS

Articolo	Descrizione	Dimensione	Prezzo
CU. 04333PD12	 Cuneo / Wedge	35x30x10 DX	H9
CU. 04333PS12	 Cuneo / Wedge	35x30x10 SX	H9
CU. 04332PD05	 Cuneo / Wedge	25x30x10 DX	H9
CU. 04331PS23	 Cuneo / Wedge	50x30x10 SX	H9
VU. DS.04	 Vite / Screw	M10x22	A45
VU. OP.02	 Ogiva / Nut	M10	A47
SC. CM.04	 Chiave / Allen Key	B5	A27

S6. 04331PD23
List. F50

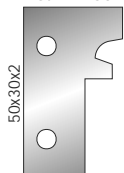

S6. 04332PS05
List. F33





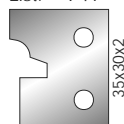

S6. 04333PS12
List. F41

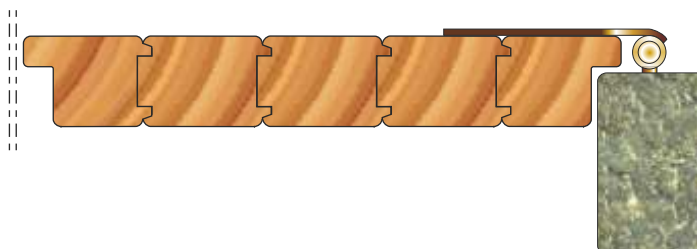
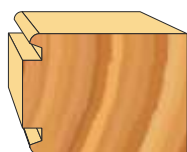
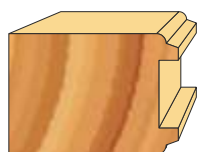
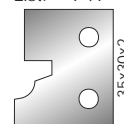

S6. 04333PD12
List. F41



GRUPPI FRESE PER PERLINE E PAVIMENTI

-  - GROUPS OF CUTTERS FOR WOOD-BLOCK FLOORINGS
-  - GROUPES DE FRAISES POUR BOUVETAGE RAINURE-LANGUETTE
-  - FRAESERGRUPPE FUER SPUNDUNG-PARKETTS
-  - GRUPO DE FRESAS PARA MACHIHEMBRADOS Y PARQUETES

TT.03

Ø	n.min.	n.max.
167		8100

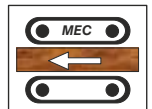

Articolo	D	B	d	Z	Riferimento	↶	↷	Prezzo
TT. 03.01	149	40	30/35/40/50	3	Gruppo 01	SX		T 1
TT. 03.02	154	40	30/35/40/50	3	Gruppo 02		DX	T 2
TT. 03.03	150	40	30/35/40/50	3	Gruppo 03	SX		T 3
TT. 03.04	154	40	30/35/40/50	3	Gruppo 04		DX	T 4
TT. 03.05	167	40	30/35/40/50	3	Gruppo 05	SX		T 5
TT. 03.06	154	40	30/35/40/50	3	Gruppo 06		DX	T 6
TT. 03.07	167	40	30/35/40/50	3	Gruppo 07	SX		T 7
TT. 03.08	154	40	30/35/40/50	3	Gruppo 08		DX	T 8
TT. 03.09	152	30	30/35/40/50	3	Gruppo 09	SX		T 9
TT. 03.10	150	30	30/35/40/50	3	Gruppo 10		DX	T 10
TT. 03.11	166	30	30/35/40/50	3	Gruppo 11	SX		T 11
TT. 03.12	150	30	30/35/40/50	3	Gruppo 12		DX	T 12
TT. 03.13	159	40	30/35/40/50	3	Gruppo 13	SX		T 13
TT. 03.14	154	40	30/35/40/50	3	Gruppo 14		DX	T 14
TT. 03.15	159	40	30/35/40/50	3	Gruppo 15	SX		T 15
TT. 03.16	154	40	30/35/40/50	3	Gruppo 16		DX	T 16

La rotazione standard è prevista per macchina scorniciatrice. A richiesta versione per toupie.

The tools are supplied for standard rotation used on moulding machines. On request toupie version.

Les sens de rotation standard est prevue pour machines pour moulurières. Tranchants commandés version pour toupie.







Die Standard Drehrichtung ist für mehrspindelige Kehlmaschinen vorgesehen. Auf wunsch ausführung für toupie.

La rotación standard está prevista haciendo de gaia la parte de la ranura. Sobre demanda version para toupie.





RICAMBI-SPARE PARTS-RECHANGES-ERSATZTEILE-RECAMBIOS

Articolo	Descrizione	Dimensione	Prezzo
S0. CF.20	 Coltello / Knife	20x12x1,5	B6
CU. TB.06	 Cuneo / Wedge	20x12x10	A1
VU. DS.03	 Vite / Screw	M8x22	A45
VU. OC.02	 Ogiva / Nut	M8	A46
SC. CM.03	 Chiave / Allen Key	B 4	A27
S0. CF.08	 Coltello / Knife	7,65x12x1,5	B1
CU. TB.01	 Cuneo / Wedge	8x12x10	A1
VU. GC.06	 Vite / Screw	M6x16	A37
SC. CM.02	 Chiave / Allen Key	B 3	A27

RICAMBI-SPARE PARTS-RECHANGES-ERSATZTEILE-RECAMBIOS

Articolo	Descrizione	Dimensione	Prezzo
S4. RA.01	 Rasante / Shavers	14x14x2	E14
VU. RB.02	 Vite / Screw	M5x8	G42
SC. CT.03	 Chiave / Allen Key	T20	A30
S7. SB.01	 Spigolatori / Chanfering	26.8x15.8 45°	F21
S7. SB.02	 Spigolatori / Chanfering	26.8x15.8 45°	F21
S7. SB.05	 Spigolatori / Chanfering	26.8x15.8 R3	F23
S7. SB.06	 Spigolatori / Chanfering	26.8x15.8 R3	F23
S5. SB.04	 Settore / Sectors	25x20x4	F2
VU. VS.02	 Vite / Screw	M6x15	A44



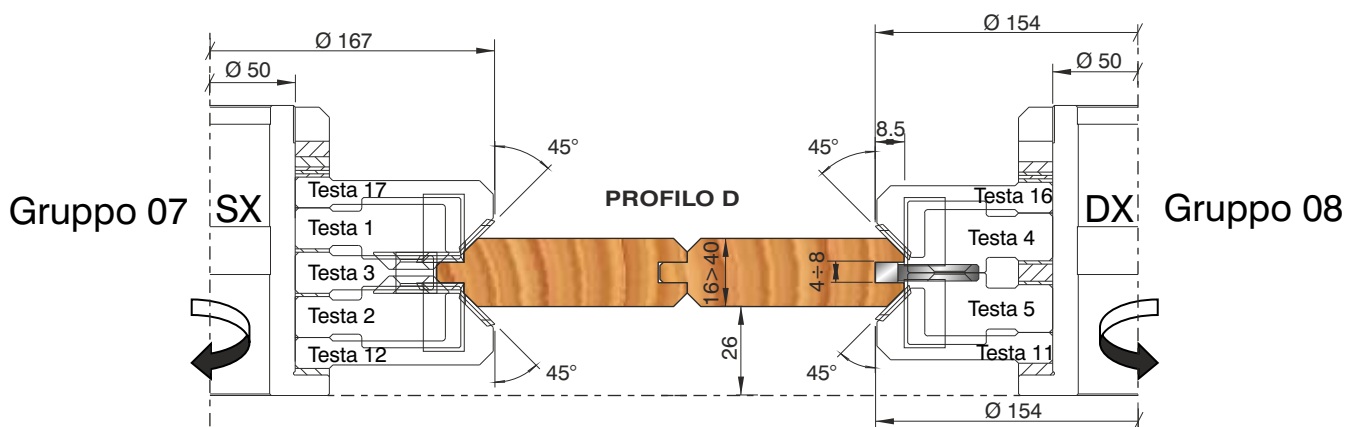
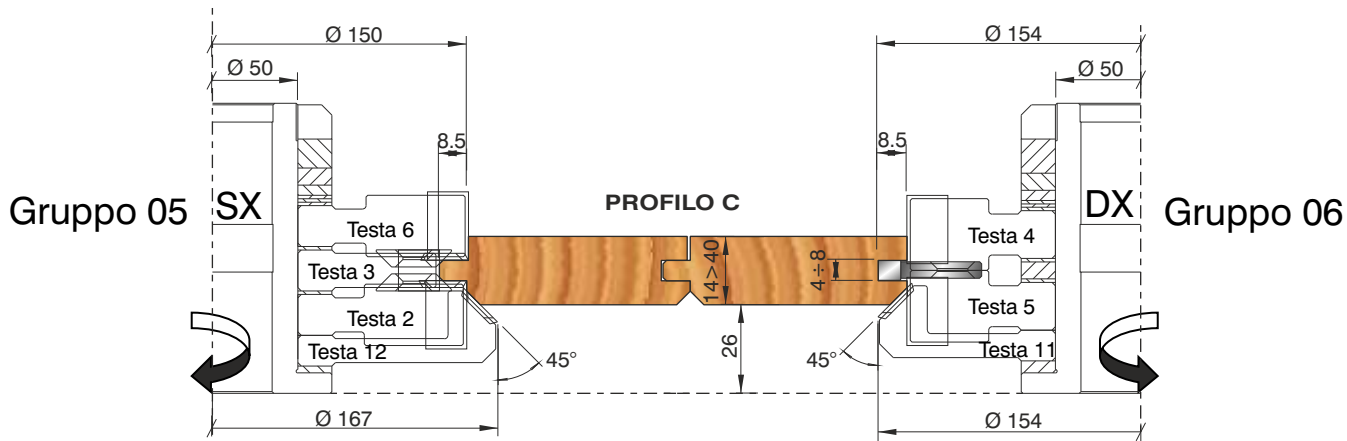
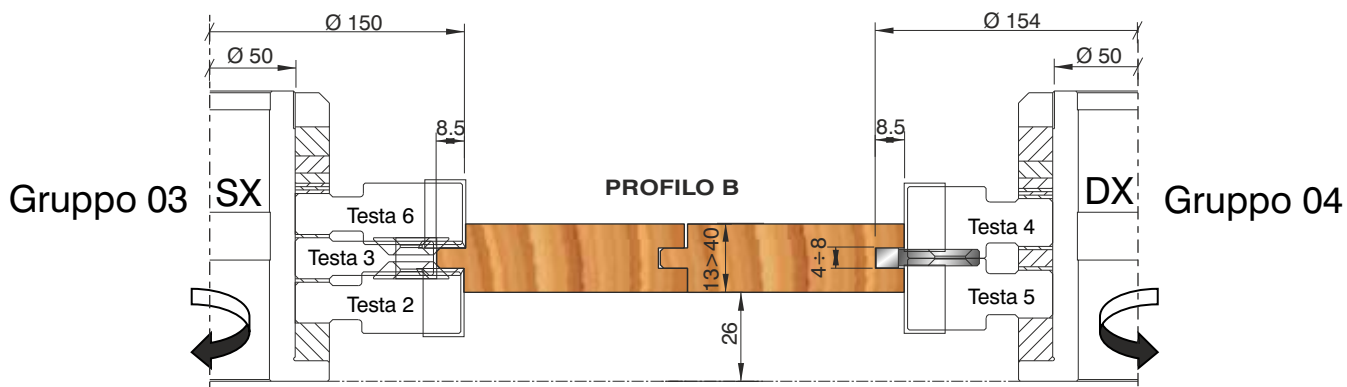
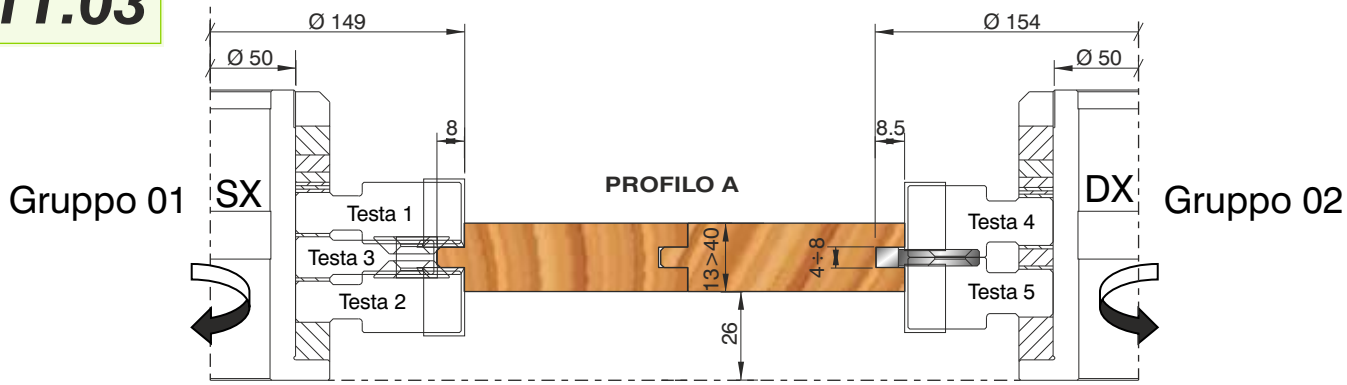

GRUPPI FRESE PER PERLINE E PAVIMENTI

-  - GROUPS OF CUTTERS FOR WOOD-BLOCK FLOORINGS
-  - GROUPES DE FRAISES POUR BOUVETAGE RAINURE-LANGUETTE
-  - FRAESERGRUPPE FUER SPUNDUNG-PARKETTS
-  - GRUPO DE FRESAS PARA MACHIHEMBRADOS Y PARQUETES

TT.03





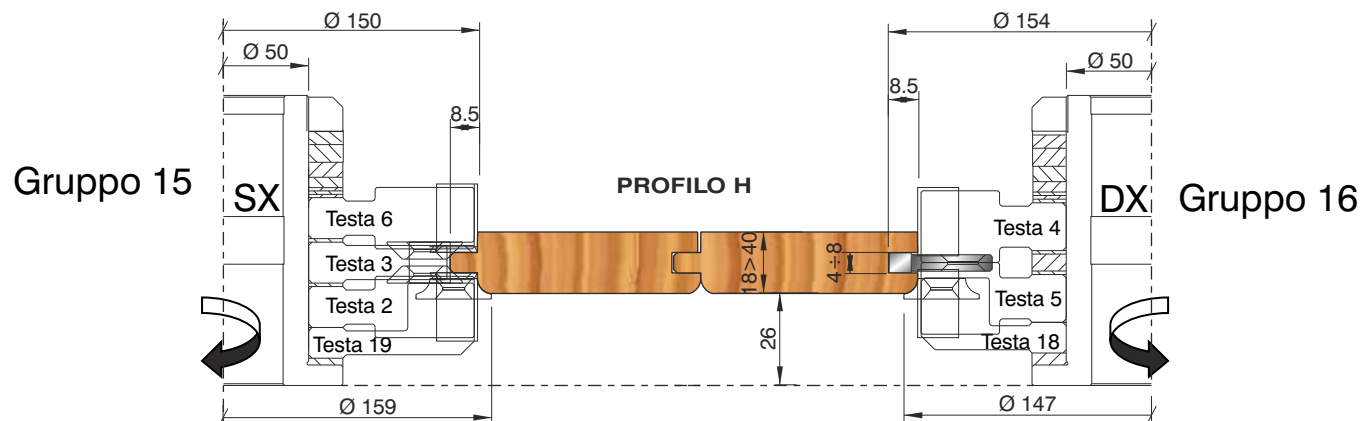
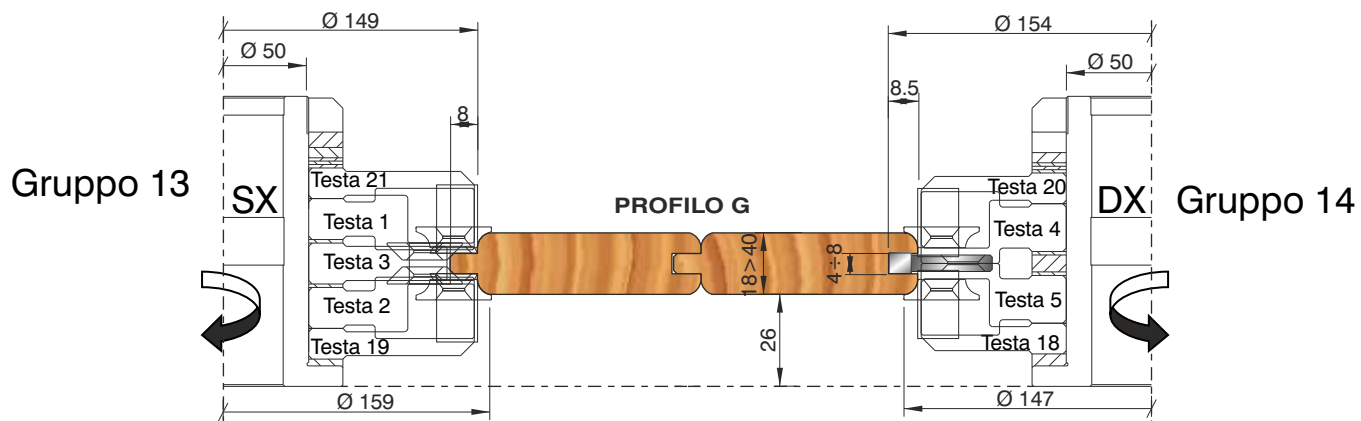
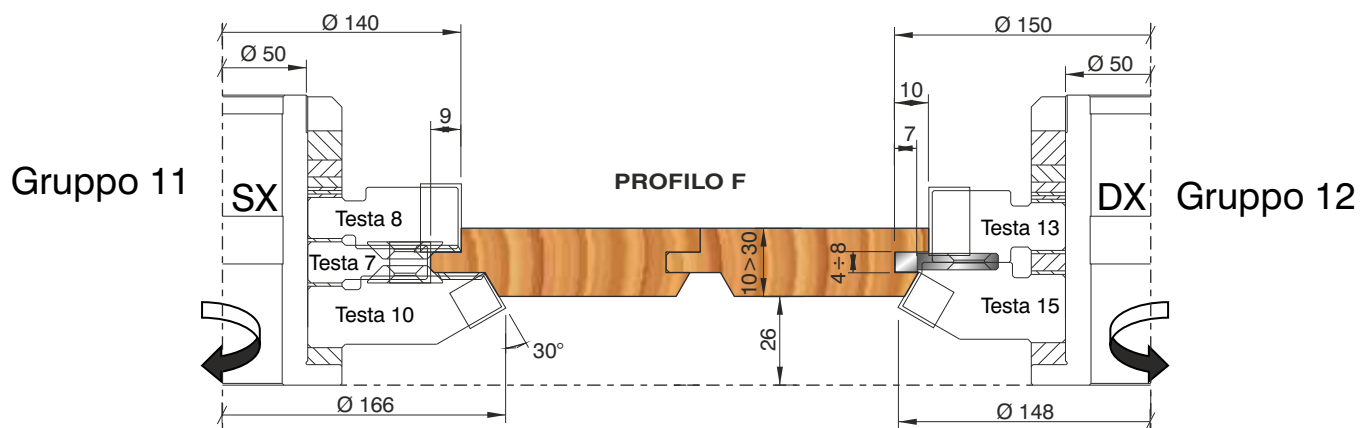
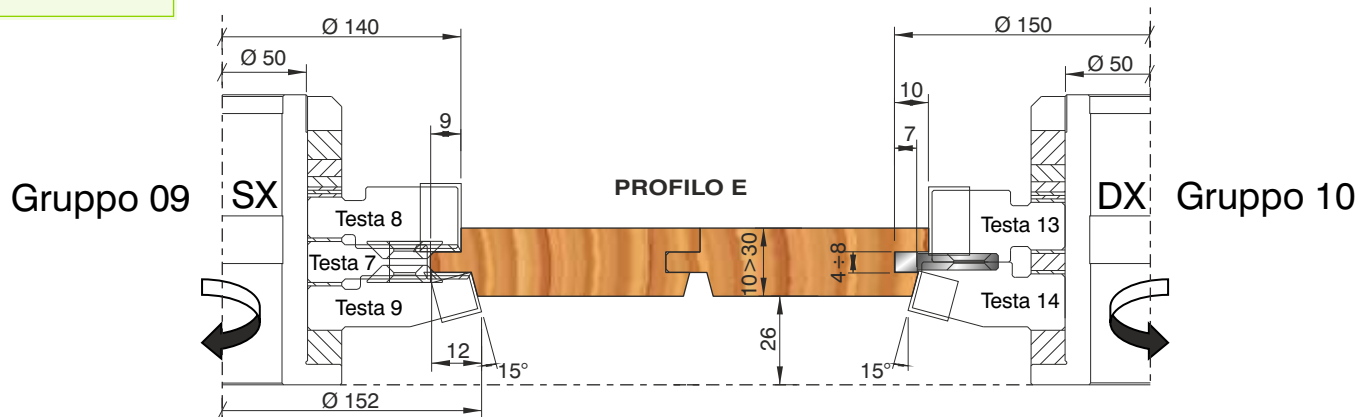

GRUPPI FRESE PER PERLINE E PAVIMENTI

-  - GROUPS OF CUTTERS FOR WOOD-BLOCK FLOORINGS
-  - GROUPES DE FRAISES POUR BOUVETAGE RAINURE-LANGUETTE
-  - FRAESERGRUPPE FUER SPUNDUNG-PARKETTS
-  - GRUPO DE FRESAS PARA MACHIHEMBRADOS Y PARQUETES

TT.03



GRUPPI FRESE PER GIUNZIONI PER BALCONI ESTERNI

-  - GROUPS OF CUTTERS FOR JOINTS FOR OUTSIDE BALCONY
-  - GROUPES DE FRAISES POUR ASSEMBLAGES POUR BALCON EXTÉRIEUR
-  - VERBINDUNGS FRAESERGRUPPE FUER AUSSENBALKONE
-  - GRUPO DE FRESAS PARA ENSAMBLES PARA BALCÓN EXTERIOR

TT.04

Ø	n.min.	n.max.
150		8500

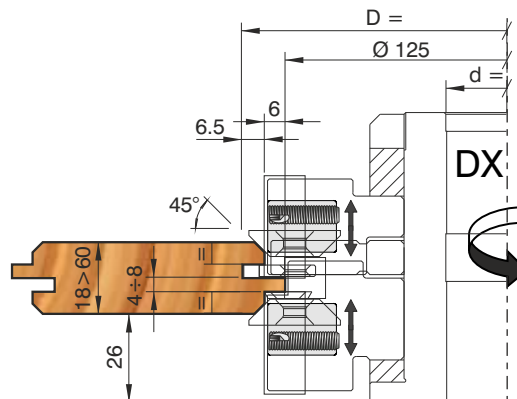
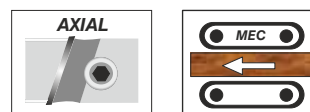

Articolo	D	B	d	Z	R	T	↶	↷	Prezzo
TT. 04.01	150	60	30/35/40/50	2	2	2		DX	T 17

NB: d=50 (Senza mozzo/Without sleeve/Sin casquillo/Ohne Spannbuchse/Sans manchon)

RICAMBI-SPARE PARTS-RECHANGES-ERSATZTEILE-RECAMBIOS

Articolo	Descrizione	Dimensione	Prezzo
S0. CF.30	 Coltello / Knife	30x12x1,5	B8
CU. TB.08	 Cuneo / Wedge	30x12x10	A1
VU. DS.03	 Vite / Screw	M8x22	A45
VU. OC.02	 Ogiva / Nut	M8	A46
SC. CM.03	 Chiave / Allen Key	B 4	A27
S0. CF.12	 Coltello / Knife	12x12x1,5	B4
CU. TB.04	 Cuneo / Wedge	12x12x10	A1
VU. DS.01	 Vite / Screw	M6x18	A45
VU. OC.01	 Ogiva / Nut	M6	A46
S4. RA.01	 Rasante / Shavers	14x14x2	E14
VU. RB.02	 Vite / Screw	M5x8	G42
SC. CT.03	 Chiave / Allen Key	T20	A30
S5. SB.04	 Settore / Sectors	25x20x4	F2
VU. VS.02	 Vite / Screw	M6x15	A44
S7. SB.01	 Spigolatori / Chanfering	26.8x15.8 45°	F21
S7. SB.02	 Spigolatori / Chanfering	26.8x15.8 45°	F21
S7. PM.01	 Supporti / Supports	Tipo C	A4
VU. GC.06	 Vite / Screw	M6x16	A37
SC. CM.02	 Chiave / Allen Key	B 3	A27

Frese combinate a spessore variabile per eseguire giunzioni su qualsiasi tipo di legno.

Combined, variable thickness cutters for making joints on any type of wood.



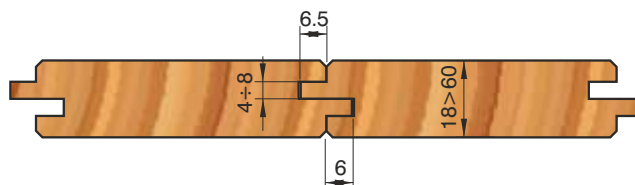
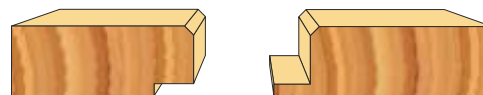
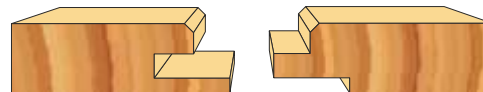

Fraises combinées à épaisseur variable pour réaliser des assemblages sur n'importe quel type de bois.

Kombinierte Fraeser mit verschiedenen Staerken zur Herstellung von Verbindungen geeignet fuer alle Holzarten.

Fresa para ensambles sobre cualquier tipo de madera.



CONFEZIONE DI FRESE PER PERLINE E PAVIMENTI

-  - GROUPS OF CUTTERS FOR WOOD-BLOCK FLOORINGS
-  - GROUPES DE FRAISES POUR BOUVETAGE RAINURE-LANGUETTE
-  - FRAESERGRUPPE FUER SPUNDUNG-PARKETTS
-  - GRUPO DE FRESAS PARA MACHIHEMBRADOS Y PARQUETES

TT.05

Ø	n.min.	n.max.
167		8100

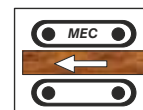

Articolo	D	B	d	Z	Elemento N°	↶	↷	Prezzo
TT. 05.01	149÷167	13÷40	30/35/40/50	3	1-2-3-4-5-6-7-8-9-10-11 12-13-14-15-16-17-18	SX	DX	T 35

Il set comprende 18 elementi intercambiabili con 2 mozzi portautensili completi di anelli distanziatori. Le diverse combinazioni permettono l'esecuzione di 12 profili differenti.

La rotazione standard è prevista per macchine scorniciatrici. A richiesta versione per toupie

The set is composed of 18 interchangeable elements and two sleeves complete with spacers. It is possible to combine the different elements for 12 different profiles.

The tools are supplied for standard rotation used on moulding machines. On request toupie version

L'ensemble comprend 18 éléments interchangeables, Outil avec deux moyeux complets avec des bagues d'écartement. Les différentes combinaisons de permettre l'exécution de 12 différents profils.

Le sens de rotation standard est prévue pour machines pour moulurières. Tranchants commandes version toupie

Fraesersatz besteht aus 18 kombinierbaren Elementen plus zwei Spindelflanschen und Distanzringe. Die verschiedene Kombination der Werkzeuge ermöglicht die Herstellung von 12 verschiedenen Profilen.

Die Standard Drehrichtung ist fuer mehrspindelige Kehlmaschinen vorgesehen. Auf Wunsch Ausfuehrung fuer toupie

El conjunto comprende 18 elementos intercambiables más 2 tubos de montaje completos de anillos distanciadores. Combinando los utensilios, se puede conseguir más de 12 perfiles distintos.

La rotación standard esta prevista haciendo de guaa la parte de la ranura. Sobre demanda version para toupie





RICAMBI-SPARE PARTS-RECHANGES-ERSATZTEILE-RECAMBIOS

Articolo	Descrizione	Dimensione	Prezzo
S0. CF.20	 Coltello / Knife	20x12x1,5	B6
CU. TB.06	 Cuneo / Wedge	20x12x10	A1
VU. DS.03	 Vite / Screw	M8x22	A45
VU. OC.02	 Ogiva / Nut	M8	A46
SC. CM.03	 Chiave / Allen Key	B 4	A27
S0. CF.08	 Coltello / Knife	7,65x12x1,5	B1
CU. TB.01	 Cuneo / Wedge	8x12x10	A1
VU. GC.06	 Vite / Screw	M6x16	A37
SC. CM.02	 Chiave / Allen Key	B 3	A27

RICAMBI-SPARE PARTS-RECHANGES-ERSATZTEILE-RECAMBIOS

Articolo	Descrizione	Dimensione	Prezzo
S4. RA.01	 Rasante / Shavers	14x14x2	E14
VU. RB.02	 Vite / Screw	M5x8	G42
SC. CT.03	 Chiave / Allen Key	T20	A30
S7. SB.01	 Spigolatori / Chanfering	26.8x15.8 45°	F21
S7. SB.02	 Spigolatori / Chanfering	26.8x15.8 45°	F21
S7. SB.05	 Spigolatori / Chanfering	26.8x15.8 R3	F23
S7. SB.06	 Spigolatori / Chanfering	26.8x15.8 R3	F23
S5. SB.04	 Settore / Sectors	25x20x4	F2
VU. VS.02	 Vite / Screw	M6x15	A44

CONFEZIONE DI FRESE PER PERLINE E PAVIMENTI

-  - GROUPS OF CUTTERS FOR WOOD-BLOCK FLOORINGS
-  - GROUPES DE FRAISES POUR BOUVETAGE RAINURE-LANGUETTE
-  - FRAESERGRUPPE FUER SPUNDUNG-PARKETTS
-  - GRUPO DE FRESAS PARA MACHIHEMBRADOS Y PARQUETES

TT.05

