





# TESTE SAGOMATE



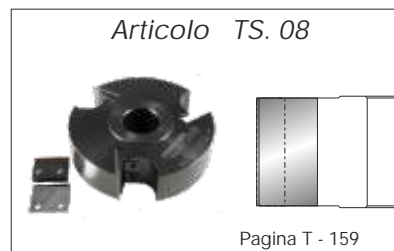
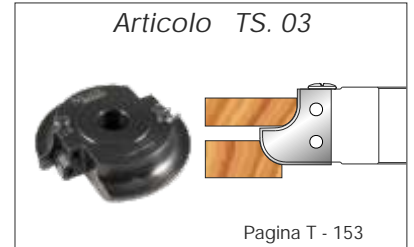
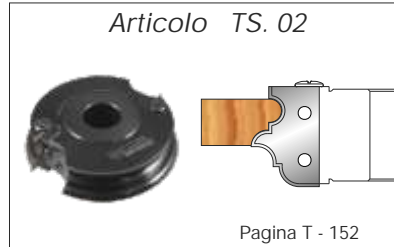

-  - PROFILED TOOLS
-  - FRAISER PROFIL
-  - PROFILFRÄSER
-  - FRESAS PARA MOLDURA

TS





# TESTE PORTACOLTELLI SAGOMATI MULTIRAGGI

-  - PROFILE CUTTERHEADS MULTIRADIUS
-  - PORTE-OUTILS AVEC COUTEAUX PROFILÉS MULTI QUART-DE ROUNDS
-  - RADIEN PROFILMESSERKOPF
-  - CABEZALES DE CUCHILLAS PERFILADOS MULTI-RADIOS

## TS.01

Ø	n.min.	n.max.
140	5500	8800
180	4200	7800

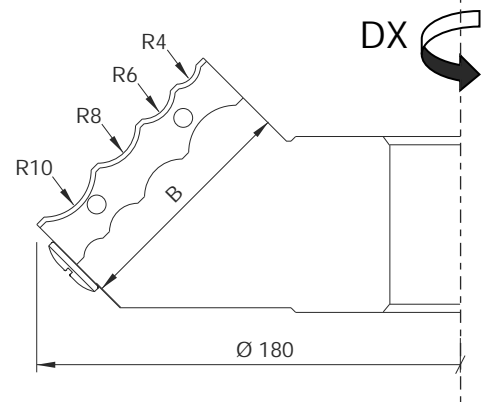
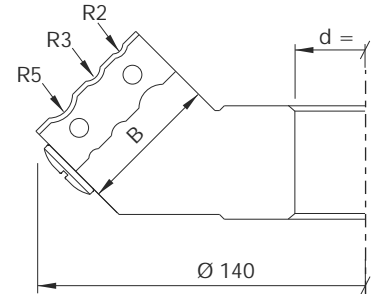
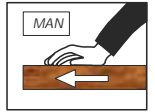

Articolo	D	B	d	Z	↶	↷	Prezzo
TS. 01.01	140	30	30/35/40/50	2		DX	S 39
TS. 01.02	180	50	30/35/40/50	2		DX	S 40



### RICAMBI-SPARE PARTS-RECHANGES-ERSATZTEILE-RECAMBIOS

Articolo	Descrizione	Dimensione	Prezzo
CU. 04021FD30	 Cuneo / Wedge	30x12x10 DX	A3
CU. 04022FD50	 Cuneo / Wedge	50x12x10 DX	A3
VU. DS.03	 Vite / Screw	M8x22	A45
VU. OC.02	 Ogiva / Nut	M8	A46
SC. CM.03	 Chiave / Allen Key	B4	A27

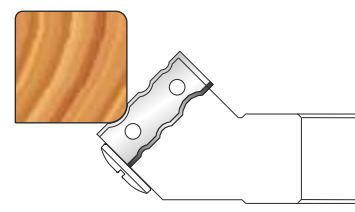
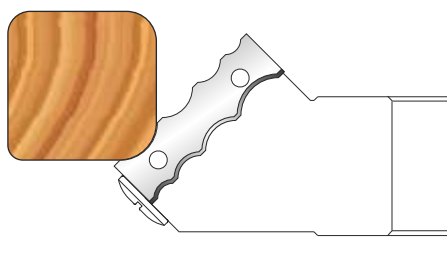
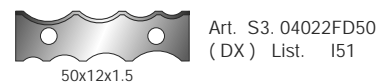
I raggi disponibili sono : ( R= 2 / 3 / 5 ) - ( R= 4 / 6 / 8 / 10 ).  
 The available radiuses are : ( R= 2 / 3 / 5 ) - ( R= 4 / 6 / 8 / 10 ).  
 Les rayons disponibles sont : ( R= 2 / 3 / 5 ) - ( R= 4 / 6 / 8 / 10 ).  
 Die erhältlichen Radien sind : ( R= 2 / 3 / 5 ) - ( R= 4 / 6 / 8 / 10 ).  
 Los radios disponibles son : ( R= 2 / 3 / 5 ) - ( R= 4 / 6 / 8 / 10 ).



# TESTE PORTACOLTELLI SAGOMATI MULTIPROFILO

-  - MULTIPROFIL CUTTERHEADS
-  - PORTE-OUTILS AVEC COUTEAUX PROFILÉS MULTIPROFIL
-  - MULTIPROFIL-MESSERKOPFE
-  - CABEZALES DE CUCHILLAS PERFILADOS MULTIPERFIL



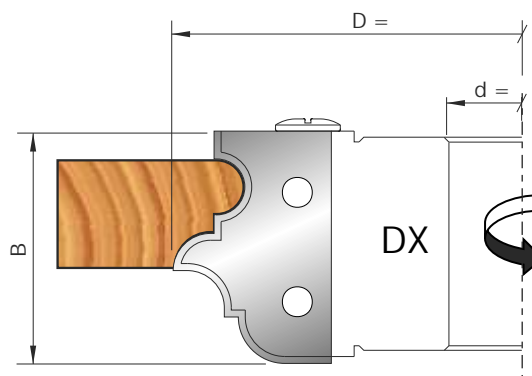
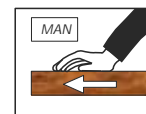

TS.02

Ø	n.min.	n.max.
162	4700	8200



Articolo	D	B	d	Z	↶	↷	Prezzo
TS. 02.01	162	50	30/35/40/50	2		DX	S 41

Fresa con coltelli sagomati HW standard.  
*Cutters with standard profile knives.*  
 Fraise à plaquettes avec profilés standard.  
*Fraeser mit standard profil-messern.*  
 Fresa con cuchillas perfilados standard.

RICAMBI-SPARE PARTS-RECHANGES-ERSATZTEILE-RECAMBIOS				
Articolo		Descrizione	Dimensione	Prezzo
CU. 04303PD24		Cuneo / Wedge	50x35x10 DX	H9
VU. DS.04		Vite / Screw	M10x22	A45
VU. OP.02		Ogiva / Nut	M10	A47
SC. CM.04		Chiave / Allen Key	B5	A27

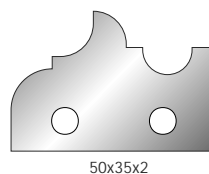



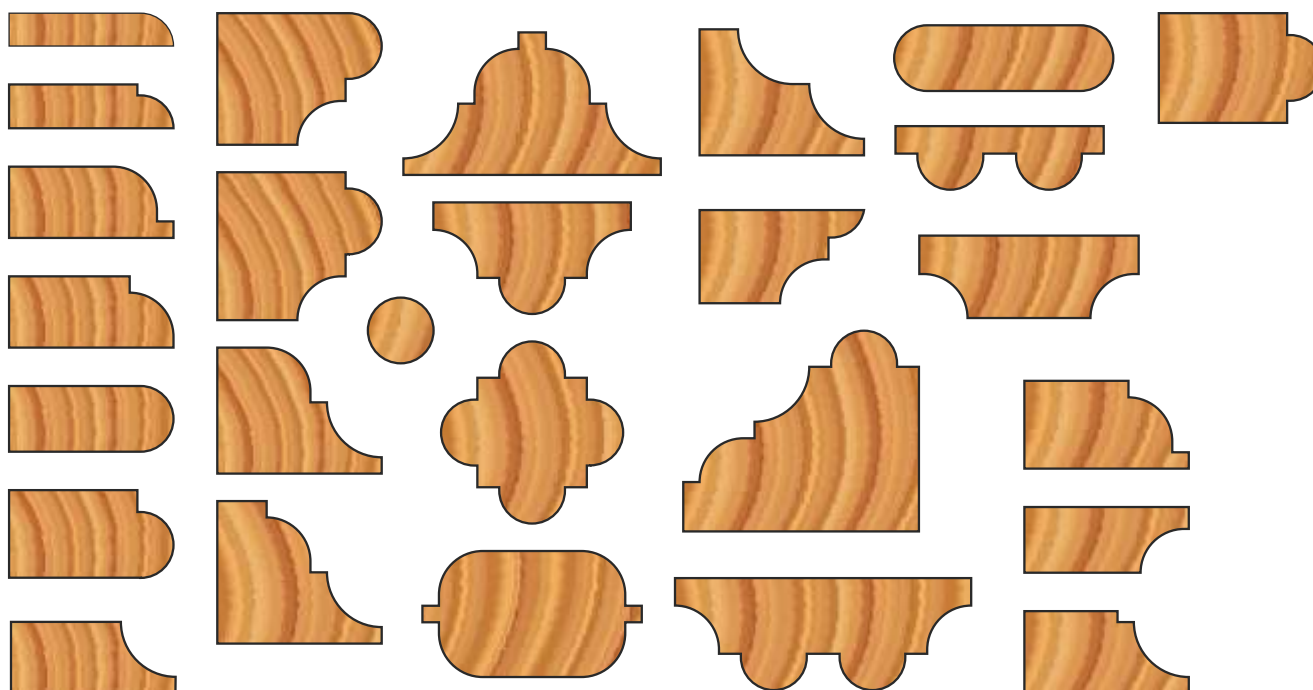

S6. 04303PD24  
List. F51

50x35x2



# FRESA 1/4 TONDO CONVESSO CONCAVO

-  - QUARTER ROUND CONVEX-CONCAVE RADIUS SHAPER CUTTER
-  - FRAISE À RAYON 1/4 DE ROND CONVEXE-CONCAVE
-  - PROFILFRÄSER FÜR KONVEXE-KONKAVE VIERTELKREISE
-  - FRESA PARA REDIOS 1/4 DE TONDO CÓNVEJO-CONCAVO



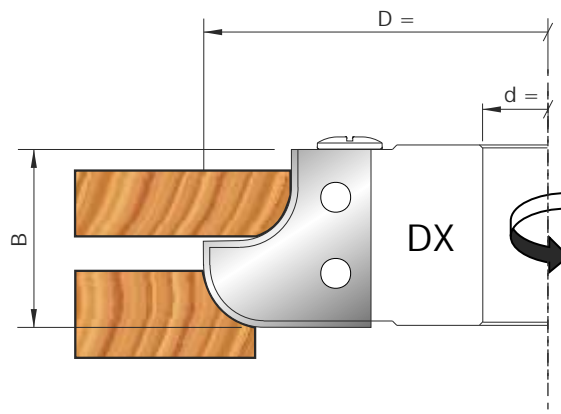
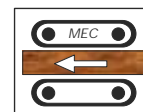

**TS.03**

Ø	n.min.	n.max.
160		8300



Articolo	D	B	d	Z	↶	↷	Prezzo
TS. 03.01	160	40	30/35/40/50	2		DX	S 42

**RICAMBI-SPARE PARTS-RECHANGES-ERSATZTEILE-RECAMBIOS**

Articolo	Descrizione	Dimensione	Prezzo
CU. 04310PD17	 Cuneo / Wedge	40x35x10 DX	H9
VU. DS.04	 Vite / Screw	M10x22	A45
VU. OP.02	 Ogiva / Nut	M10	A47
SC. CM.04	 Chiave / Allen Key	B5	A27

L'utensile viene fornito completo di 5 serie di coltelli:  
( R8 / R10 / R12 / R15 / R17.5 ).

*The tool is supplied complete with 5 set of knives:  
( R8 / R10 / R12 / R15 / R17.5 ).*

Le port-outils vient livré complete avec 5 jru de plaquettes:  
( R8 / R10 / R12 / R15 / R17.5 ).

*MesserKopfsatz geliefert mit 5 Typen von Abrund-Messer:  
( R8 / R10 / R12 / R15 / R17.5 ).*

La herramienta se suministra con 5 serie de cuchillas:  
( R8 / R10 / R12 / R15 / R17.5 ).

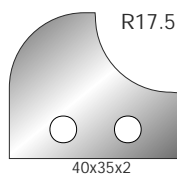
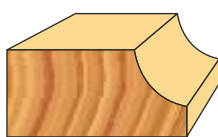

S6. 04310PD17  
List. F47

40x35x2

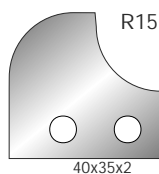

S6. 04311PD17  
List. F47

40x35x2

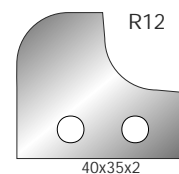

S6. 04312PD17  
List. F47

40x35x2

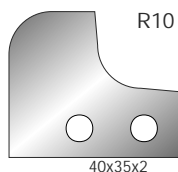

S6. 04313PD17  
List. F47



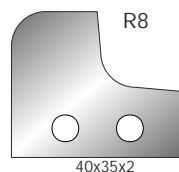

40x35x2



S6. 04314PD17  
List. F47

40x35x2

# FRESA 1/4 TONDO CONCAVO

-  - QUARTER ROUND CONCAVE RADIUS SHAPER CUTTER
-  - FRAISE À RAYON 1/4 DE ROND CONCAVE
-  - PROFILMESSERKOPF FÜR KONKAVE VIERTELKREISE
-  - FRESA PARA REDIOS 1/4 DE TONDO CONCAVO

TS.04

Ø	n.min.	n.max.
150		8300

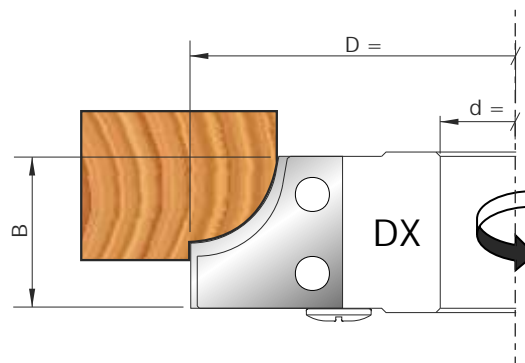
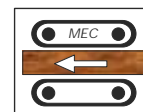

Articolo	D	B	d	Z	↶	↷	Prezzo
TS. 04.01	160	35	30/35/40/50	3		DX	S 43





L'utensile viene fornito completo di 3 serie di coltelli:  
( R10 / R15 / R20 ).

The tool is supplied complete with 3 set of knives:  
( R10 / R15 / R20 ).

Le port-outils vient livré complete avec 3 jru de plaquettes:  
( R10 / R15 / R20 ).

MesserKopfsatz geliefert mit 3 Satz von Abrund-Messer:  
( R10 / R15 / R20 ).

La herramienta se suministra con 3 serie de cuchillas:  
( R10 / R15 / R20 ).



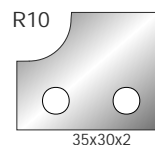
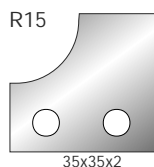
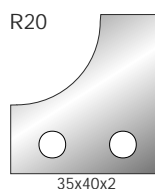
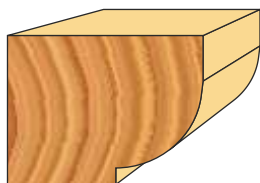

RICAMBI-SPARE PARTS-RECHANGES-ERSATZTEILE-RECAMBIOS			
Articolo	Descrizione	Dimensione	Prezzo
CU. 04320PD11	 Cuneo / Wedge	35x25x10 DX	H9
VU. DS.04	 Vite / Screw	M10x22	A45
VU. OP.02	 Ogiva / Nut	M10	A47
SC. CM.04	 Chiave / Allen Key	B5	A27

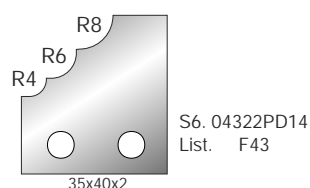
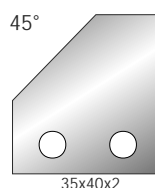

- Profilo a richiesta.
- Profile on request.
- Profil sur demande.
- Zeichnung oder Holzmuster.
- Perfil bajo pedido.



# FRESA 1/4 TONDO CONVESSO

-  - QUARTER ROUND CONVEX RADIUS SHAPER CUTTER
-  - FRAISE À RAYON 1/4 DE ROND CONVEXE
-  - PROFILFRÄSER FÜR KONVEXE VIERTELKREISE
-  - FRESA PARA REDIOS 1/4 DE TONDO CÓNVEJO



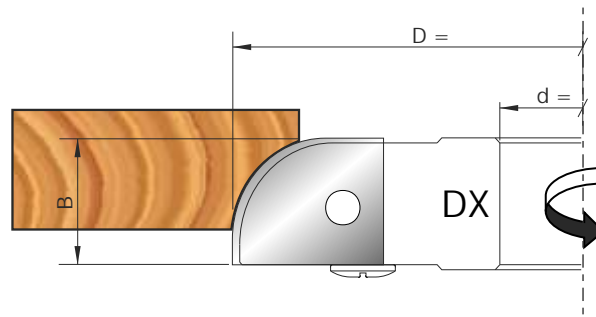
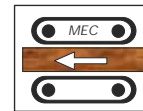

**TS.05**

∅	n.min.	n.max.
150		8500



Articolo	D	B	d	Z	↶	↷	Prezzo
TS. 05.01	150	25	30/35/40/50	3		DX	S 44

## RICAMBI-SPARE PARTS-RECHANGES-ERSATZTEILE-RECAMBIOS

Articolo	Descrizione	Dimensione	Prezzo
CU. 04315PD05	 Cuneo / Wedge	25x30x10 DX	H9
VU. DS.04	 Vite / Screw	M10x22	A45
VU. OP.02	 Ogiva / Nut	M10	A47
SC. CM.04	 Chiave / Allen Key	B5	A27

L'utensile viene fornito completo di 3 serie di coltelli:  
( R10 / R15 / R20 ).

*The tool is supplied complete with 3 set of knives:  
( R10 / R15 / R20 ).*



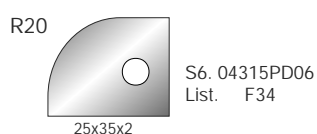

Le port-outils vient livré complete avec 3 jru de plaquettes:  
( R10 / R15 / R20 ).

*MesserKopfsatz geliefert mit 3 Satz von Abrund-Messer:  
( R10 / R15 / R20 ).*

La herramienta se suministra con 3 serie de cuchillas:  
( R10 / R15 / R20 ).



# FRESA 1/4 TONDO CONCAVO



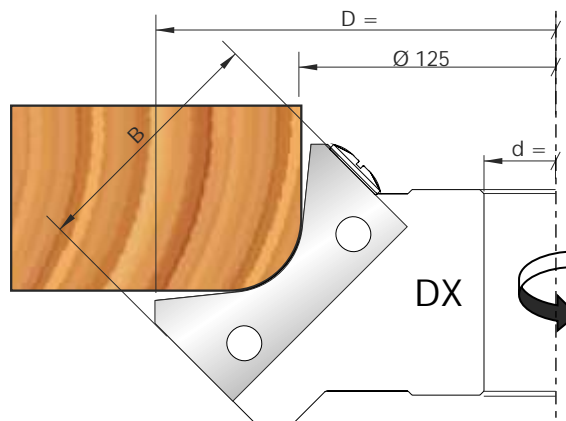
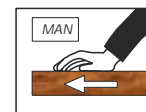

-  - QUARTER ROUND CONCAVE RADIUS SHAPER CUTTER
-  - FRAISE À RAYON 1/4 DE ROND CONCAVE
-  - PROFILMESSERKOPF FÜR KONKAVE VIERTELKREISE
-  - FRESA PARA REDIOS 1/4 DE TONDO CONCAVO

TS.06

Ø	n.min.	n.max.
197	3900	7500



Articolo	D	B	d	Z	↶	↷	Prezzo
TS. 06.01	197	60	30/35/40/50	2		DX	S 45

RICAMBI-SPARE PARTS-RECHANGES-ERSATZTEILE-RECAMBIOS			
Articolo	Descrizione	Dimensione	Prezzo
CU. 04323PD32	 Cuneo / Wedge	60x35x10 DX	H9
VU. DS.04	 Vite / Screw	M10x22	A45
VU. OP.02	 Ogiva / Nut	M10	A47
SC. CM.04	 Chiave / Allen Key	B5	A27

L'utensile viene fornito completo di 4 serie di coltelli:  
( R17.5 / R20 / R22.5 / R25 ).

The tool is supplied complete with 4 set of knives:  
( R17.5 / R20 / R22.5 / R25 ).

Le port-outils vient livré complete avec 4 jru de plaquettes:  
( R17.5 / R20 / R22.5 / R25 ).

MesserKopfsatz geliefert mit 4 Satz von Abrund-Messer:  
( R17.5 / R20 / R22.5 / R25 ).

La herramienta se suministra con 4 serie de cuchillas:  
( R17.5 / R20 / R22.5 / R25 ).

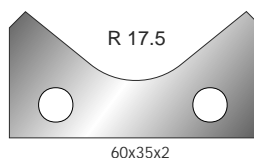

S6. 04323PD32  
List. F55

60x35x2

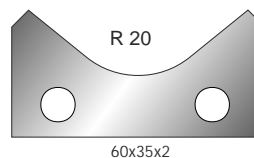

S6. 04324PD32  
List. F55

60x35x2

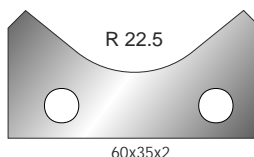

S6. 04325PD32  
List. F55

60x35x2

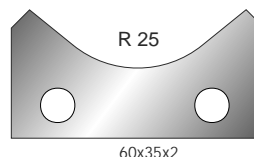





S6. 04326PD32  
List. F55

60x35x2



# TESTA PORTACOLTELLI SAGOMATI - MULTIPROFILO

-  - PROFILE CUTTERHEADS - MULTIPROFILE
-  - PORTE-OUTILS AVEC COUTEAUX PROFILÉS - MULTI-PROFILS
-  - PROFILMESSERKOPF - MULTIPROFIL
-  - CABEZALES DE CUCHILLAS PERFILADOS - MULTI-PERFIL

## TS.07

Ø	n.min.	n.max.
161		8200

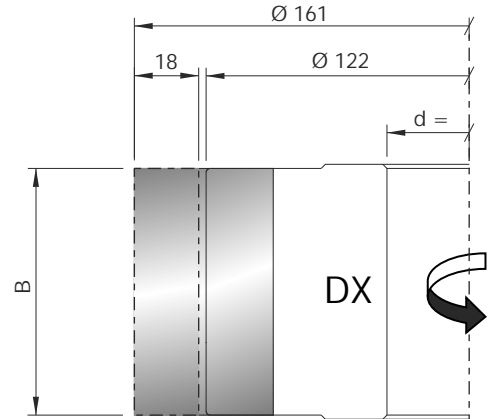
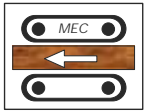

Articolo	D	B	d	Z	↶	↷	Prezzo
TS. 07.01	161	40	30/35/40/50	3	SX	DX	S 46
TS. 07.02	161	50	30/35/40/50	3	SX	DX	S 47
TS. 07.03	161	60	30/35/40/50	3	SX	DX	S 48

**Testa con placche in HW e placchette di supporto per l'esecuzione di profili sagomati su legno massiccio.**

*Cutterhead with carbide blank and back support for making shaped profiles in solid wood*

**Fraise avec plaquette carbure et porte-plaquette pour l'exécution de multiprofil-de bois massifs.**

*Messerköpfe mit hartmetall-blankett und stützplatte zur profilieren in massiv holz .*

**Fresa con en pieza en bruto de metal duro y placa de soporte para realizar perfiles de formas especiales en madera maciza.**

- L'utensile viene fornito privo di coltelli.
- The tool is supplied without knives.
- L'outil est fourni sans les couteaux.
- Das Werkzeug wird ohne Messern geliefert.
- La herramienta se entrega sin cuchillas.

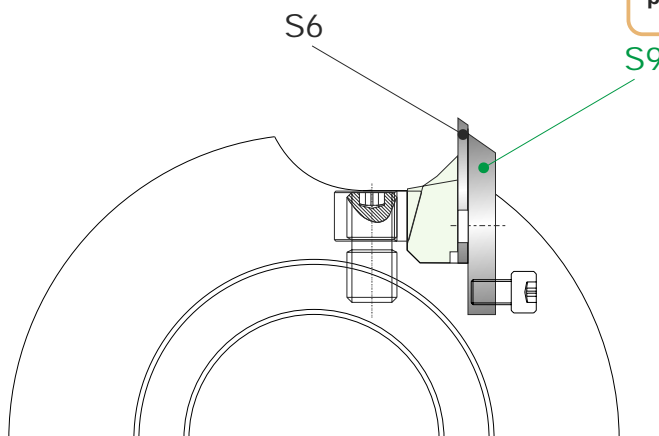

- S6** - Placchette in HW  
 - Carbide Blank  
 - Plaquette carbure  
 - Hartmetall-Blankett  
 - Pieza en bruto de metal duro

- S9** - Placchette di supporto  
 - Back Support  
 - Porte-plaquette  
 - Stützplatte  
 - Placa de soporte

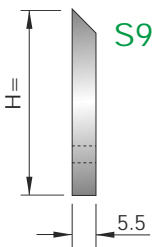





### RICAMBI-SPARE PARTS-RECHANGES-ERSATZTEILE-RECAMBIOS

Articolo	Descrizione	Dimensione	Prezzo
VU. SA.01	 Vite / Screw	M5x8	G48
SC. CM.03	 Chiave / Allen Key	B4	A27

Articolo	B	H	Tipo	Codice Prezzo	Codice Prezzo
TS. 07.50	40	35	Profilato	I 52	
TS. 07.51	50	35	Profilato	I 53	
TS. 07.52	60	35	Profilato	I 54	
TS. 07.53	40	35	Grezzo		I 55
TS. 07.54	50	35	Grezzo		L 1
TS. 07.55	60	35	Grezzo		L 2

# TESTA PORTACOLTELLI SAGOMATI - MULTIPROFILO

-  - PROFILE CUTTERHEADS - MULTIPROFILE
-  - PORTE-OUTILS AVEC COUTEAUX PROFILÉS - MULTI-PROFILS
-  - PROFILMESSERKOPF - MULTIPROFIL
-  - CABEZALES DE CUCHILLAS PERFILADOS - MULTI-PERFIL

## TS.07

IL profilo da realizzare deve essere contenuto nell'area profilabile P dell'utensile prescelto.  
*The requested profile has to be inscribed into the moulding area P of the selected tool.*  
 Le profil à exécuter doit être contenu à l'intérieur de la partie profilable P de l'outil choisi.  
*Das auszuführende Profil muss in die Profilierungsfläche «P» vom gewählten Werkzeug entgehalten sein.*  
 El perfil a realizar debe estar contenido en la parte perfilable P de l'herramienta escogida.

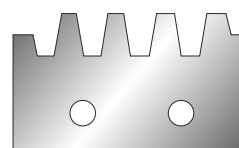
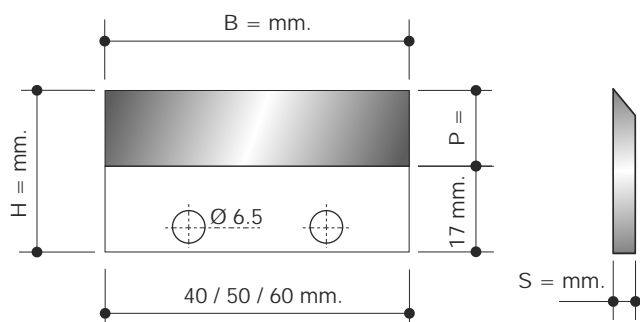

Per profili a giunzione aumento 20 %.  
*For profiles joints add 20 %.*  
 Pour profils assemblages augmentation 20 %.  
*Fuer Verbindungs-profile Aufpreis von 20 %.*  
 Para perfiles juntas aumento 20 %.

### Coltelli Profilati

Articolo	B	H	P	S	Prezzo Unitario Kit. 6 Pezzi
S6. KP.17	40	35	18	2	F 47
S6. KP.24	50	35	18	2	F 51
S6. KP.32	60	35	18	2	F 55

### Coltelli Grezzi

Articolo	B	H	P	S	Prezzo Unitario Kit. 6 Pezzi
S6. GP.17	40	35	18	2	L 6
S6. GP.24	50	35	18	2	L 7
S6. GP.32	60	35	18	2	L 8

### RICAMBI-SPARE PARTS-RECHANGES-ERSATZTEILE-RECAMBIOS

Articolo	Descrizione	Dimensione	Prezzo
VU. DS.03	 Vite / Screw	M8x22	A45
VU. OP.01	 Ogiva / Nut	M8	A47
SC. CM.03	 Chiave / Allen Key	B 4	A27
VU. DS.04	 Vite / Screw	M10x22	A45
VU. OP.02	 Ogiva / Nut	M10	A47
SC. CM.04	 Chiave / Allen Key	B 5	A27



Articolo CU	Dimensioni Cueo	Codice Prezzo
CU. 04328PD.17	40x35x12	L 3
CU. 04328PD.24	50x35x12	L 4
CU. 04328PD.32	60x35x12	L 5

# TESTE PORTACOLTELLI SAGOMATI

-  - PROFILE CUTTERHEADS
-  - PORTE-OUTILS AVEC COUTEAUX PROFILÉS
-  - PROFILMESSERKOPF
-  - CABEZALES DE CUCHILLAS PERFILADOS

## TS.08

Ø	n.min.	n.max.
161	4700	8200

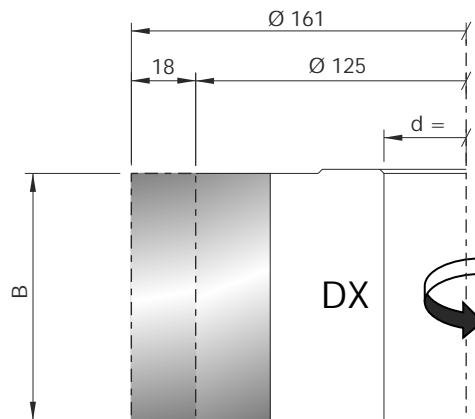
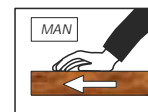

Articolo	D	B	d	Z	↶	↷	Prezzo
TS. 08.01	161	40	30/35/40/50	3	SX	DX	S 49
TS. 08.02	161	50	30/35/40/50	3	SX	DX	S 50
TS. 08.03	161	60	30/35/40/50	3	SX	DX	S 51

### RICAMBI-SPARE PARTS-RECHANGES-ERSATZTEILE-RECAMBIOS

Articolo	Descrizione	Dimensione	Prezzo
VU. DS.03	 Vite / Screw	M8x22	A45
VU. OP.01	 Ogiva / Nut	M8	A47
SC. CM.03	 Chiave / Allen Key	B 4	A27
VU. DS.04	 Vite / Screw	M10x22	A45
VU. OP.02	 Ogiva / Nut	M10	A47
SC. CM.04	 Chiave / Allen Key	B5	A27

**Testa con placche in HW per l'esecuzione di profili sagomati su legno massiccio. Teste corpi fresa profilati su richiesta.**

*Cutterhead with carbide blank for making shaped profiles in solid wood. Cutter heads made profiled on request.*

**Fraise avec plaquette carbure pour l'exécution de multiprofil-de bois masifs. Porte-outils profilées sur demande.**

*Messer köpfe mit hartmetall-blankett zur profilieren in massiv holz. Auf anfrage profilierte Messer köpfe in Sonderfertigung*

**- Fresa con en pieza en bruto de metal duro para realizar prfiles de formas especiales en madera maciza. Cabezales con cuerpo perfilados sobre demanda.**

- L'utensile viene fornito con 3 coltelli montati e 3 coltelli di ricambio.
- The tool is supplied with 3 knives mounted and 3 knives as spare parts.
- L'outil est fourni avec 3 couteaux monté et 3 couteaux de rechange.
- Das Werkzeug wird mit 3 Messern geliefert und 3 Ersatzmesser .
- La herramienta se entrega con 3 cuchillas instalade y 3 cuchillas como recambios.

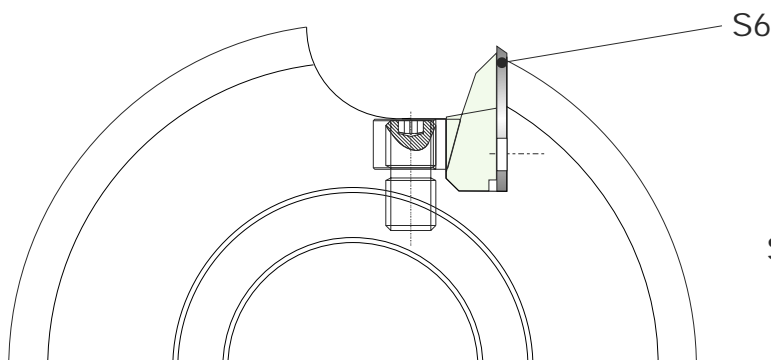

- S6**
- Placchette in HW
  - Carbide Blank
  - Plaquette carbure
  - Hartmetall-Blankett
  - Pieza en bruto de metal duro

# TESTE PORTACOLTELLI SAGOMATI

-  - PROFILE CUTTERHEADS
-  - PORTE-OUTILS AVEC COUTEAUX PROFILÉS
-  - PROFILMESSERKOPF
-  - CABEZALES DE CUCHILLAS PERFILADOS

## TS.08

- IL profilo da realizzare deve essere contenuto nell'area profilabile P dell'utensile prescelto.
- The requested profile has to be inscribed into the moulding area P of the selected tool.
- Le profil à exécuter doit être contenu à l'intérieur de la partie profilable P de l'outil choisi.
- Das ausführende Profil muss in die Profilierungfläche P vom gewählten Werkzeug entgehalten sein.
- El perfil a realizar debe estar contenido en la parte perfilable P de l'herramienta escogida.

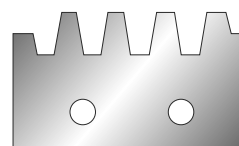
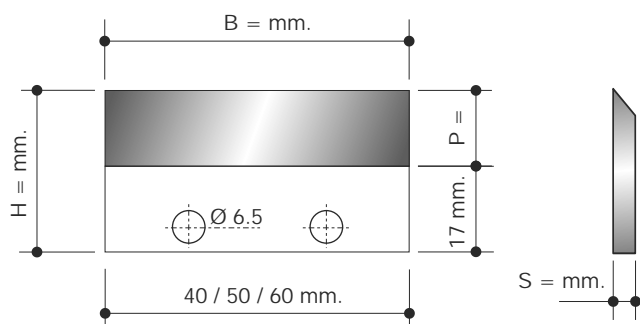

- Per profili a giunzione aumento 20 %.
- For profiles joints add 20 %.
- Pour profils ansemblages augmentation 20 %.
- Fuer Verbindungs-profile aufpreis von 20 %.
- Para perfiles juntas aumento 20 %.

### Coltelli Profilati

Articolo	B	H	P	S	Prezzo Unitario Kit. 6 Pezzi
S6. KP.17	40	35	18	2	F 47
S6. KP.24	50	35	18	2	F 51
S6. KP.32	60	35	18	2	F 55

### Coltelli Grezzi

Articolo	B	H	P	S	Prezzo Unitario Kit. 6 Pezzi
S6. GP.17	40	35	18	2	L 6
S6. GP.24	50	35	18	2	L 7
S6. GP.32	60	35	18	2	L 8



Articolo CU	Dimensioni Cueo	Codice Prezzo
CU. 04327PD.17	40x35x12	L 3
CU. 04327PD.24	50x35x12	L 4
CU. 04327PD.32	60x35x12	L 5