





# TESTE PER INCASTRI

-  - GROOVING CUTTERHEADS
-  - PORTE-OUTILS POUR RAINER
-  - NUTFRÄSER
-  - FRESAS PARA RANURAR

TI







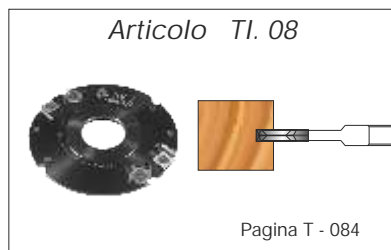
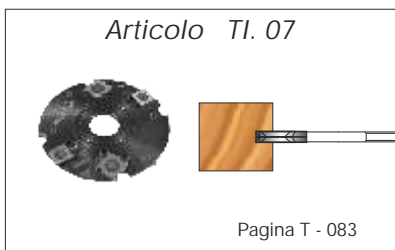
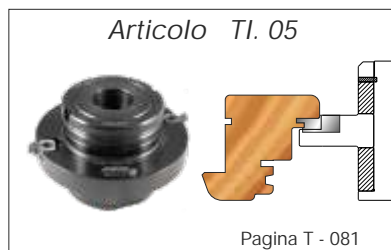
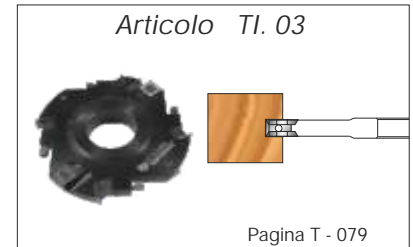
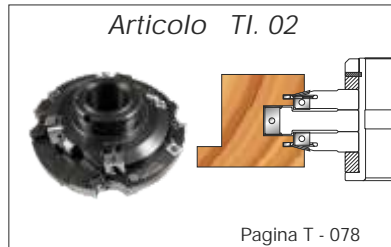
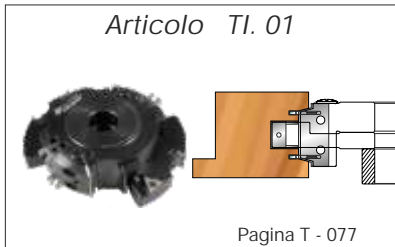

Foto by Arredo Bar Tonolli ( Brentonico TN )

NOTE

# FRESE PER SEDI FERRAMENTA PER ANTE SCORREVOLI

-  - CUTTERHEADS FOR CLOSING SYSTEMS OF SLIDING DOORS
-  - PORTE-OUTILS COULISSANTS
-  - BESCHLAG FRAESER, FUER HEBE - SCHIEBETUEREN
-  - FRESA HERRASE PARA VENTANA CORREDERA



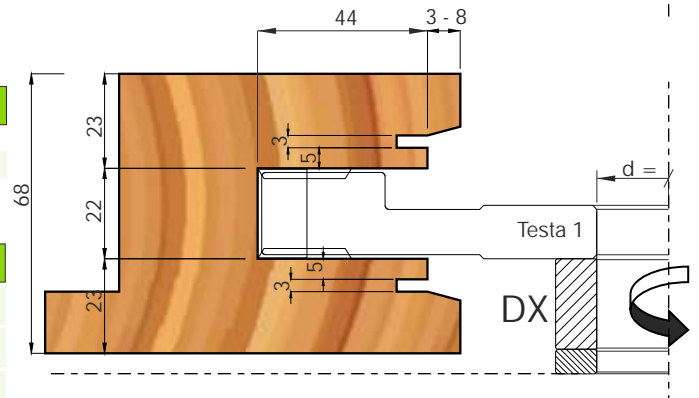
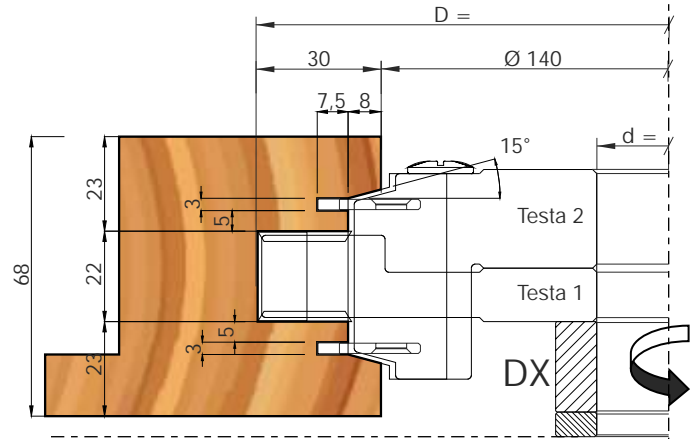
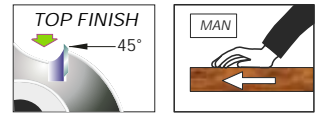

TI.01

Ø	n.min.	n.max.
200	3800	7400



Articolo	D	B	d	Z	↶	↷	Prezzo
TI. 01.01	200	68	30/35/40/50	2		DX	O 25

## RICAMBI-SPARE PARTS-RECHANGES-ERSATZTEILE-RECAMBIOS

Articolo	Descrizione	Dimensione	Prezzo
CU. TB.06	 Cuneo / Wedge	20x12x10	A1
VU. DS.03	 Vite / Screw	M8x22	A45
VU. OC.02	 Ogiva / Nut	M8	A46
SC. CM.03	 Chiave / Allen Key	B 4	A27
CU. 04058PS22	 Cuneo / Wedge	50x25x10 SX	H9
VU. TA.02	 Vite / Screw	M6x20	G36
SC. CT.04	 Chiave / Allen Key	T25	A30
S5. SB.03	 Settore / Sectors	25x20x3	F1
VU. VS.02	 Vite / Screw	M6x15	A44
S4. RT.01	 Rasante / Shavers	22.86x2.5	E19
VU. RB.02	 Vite / Screw	M5x8	G42
SC. CT.03	 Chiave / Allen Key	T20	A30

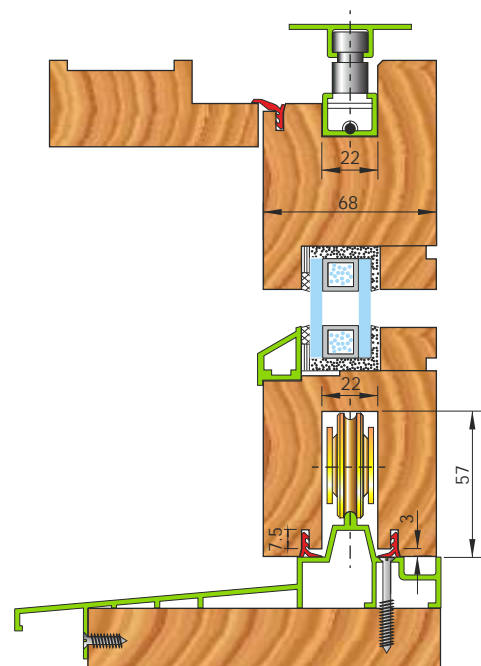

I profili possono variare secondo il tipo di ferramenta utilizzato. Nell'ordinazione indicarne sempre marca e tipo.





*The profiles can vary according to the type of metal finishings used. When ordering always indicate the mark and type.*

Les profils peuvent varier selon le type de ferrure utilisé. Sur la commande, il faut toujours indiquer la marque et le modèle

*Die Profile koennen, je nach verwendeten Beschlaegen, variieren. Bei der Bestellung immer Marke und Typ angeben.*

Los perfiles pueden variar segun el tipo de herramienta utilizado. En el pedido, indicar siempre marca y tipo.

# FRESE PER SEDI FERRAMENTA PER ANTE SCORREVOLI

-  - CUTTERHEADS FOR CLOSING SYSTEMS OF SLIDING DOORS
-  - PORTE-OUTILS COULISSANTS
-  - BESCHLAG FRAESER, FUER HEBE - SCHIEBETUEREN
-  - FRESA HERRASE PARA VENTANA CORREDERA

TI.02

Ø	n.min.	n.max.
200	3800	7400

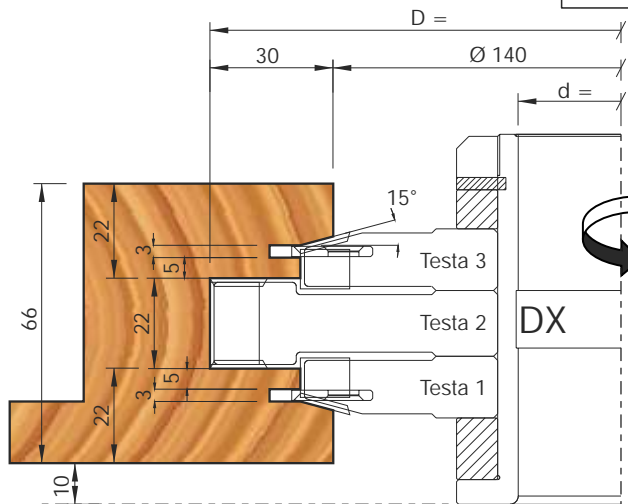
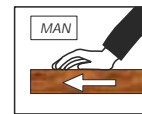

Articolo	D	B	d	Z	↶	↷	Prezzo
TI. 02.01	200	66	30/35/40/50	4+2		DX	0 27

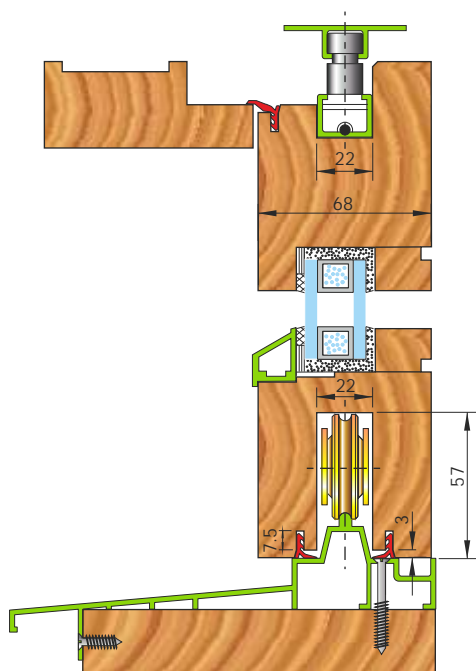
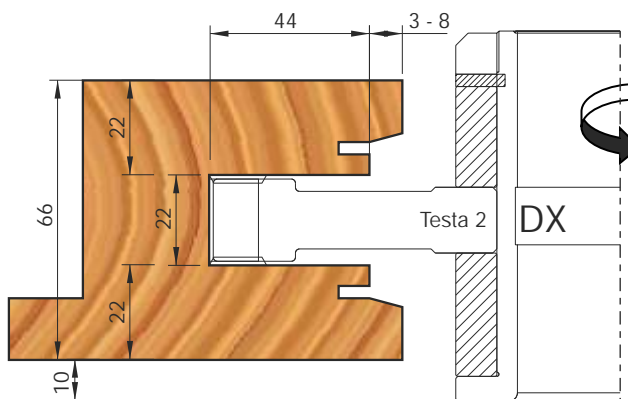

## RICAMBI-SPARE PARTS-RECHANGES-ERSATZTEILE-RECAMBIOS

Articolo	Descrizione	Dimensione	Prezzo
S0. CF.20	 Coltello / Knife	20x12x1.5	B6
CU. TB.06	 Cuneo / Wedge	20x12x10	A1
VU. DS.03	 Vite / Screw	M8x22	A45
VU. OC.02	 Ogiva / Nut	M8	A46
SC. CM.03	 Chiave / Allen Key	B 4	A27
S0. CF.10	 Coltello / Knife	9.6x12x1.5	B2
CU. TB.01	 Cuneo / Wedge	8x12x10	A1
VU. VQ.01	 Vite / Screw	M5x25	A55
SC. CQ.01	 Chiave / Allen Key	5X5	A35
S5. SB.03	 Settore / Sectors	25x20x3	F1
VU. VS.01	 Vite / Screw	M6x11.8	A44
S4. RA.01	 Rasante / Shavers	14X14x2	E14
VU. RB.02	 Vite / Screw	M5x8	G42
SC. CT.03	 Chiave / Allen Key	T20	A30

I profili possono variare secondo il tipo di ferramenta utilizzato. Nell'ordinazione indicarne sempre marca e tipo.





The profiles can vary according to the type of metal finishings used. When ordering always indicate the mark and type.

Les profils peuvent varier selon le type de ferrure utilisé. Sur la commande, il faut toujours indiquer la marque et le modèle

Die Profile koennen, je nach verwendeten Beschlaegen, variieren. Bei der Bestellung immer Marke und Typ angeben.

Los perfiles pueden variar segun el tipo de herramienta utilizado. En el pedido, indicar siempre marca y tipo.



# FRESA PER INCASTRI A SPESSORE FISSO

-  - GROOVING CUTTERS WITH FIX THICKNESS
-  - PORTE-OUTILS A RAINIER FIXE
-  - VORSCHNEID-NUTFRAESER
-  - FRESA DE RANURA FISA CON PRECORTADORES

TI.03

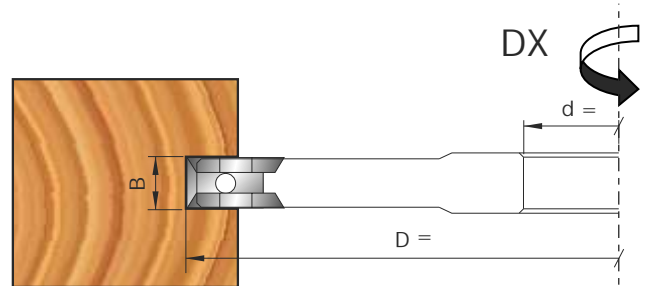
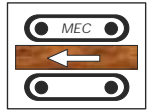
Ø	n.min.	n.max.
140	5500	8800
180	4200	7800



Articolo	D	B	d	Z	R				Prezzo
TI. 03.01	140	8	30/35/40/50	4	4	S0. CF.08	SX	DX	O 28
TI. 03.02	140	10	30/35/40/50	4	4	S0. CF.10	SX	DX	O 29
TI. 03.03	140	12	30/35/40/50	4	4	S0. CF.11	SX	DX	O 30
TI. 03.04	180	8	30/35/40/50	4	4	S0. CF.08	SX	DX	O 31
TI. 03.05	180	10	30/35/40/50	4	4	S0. CF.10	SX	DX	O 32
TI. 03.06	180	12	30/35/40/50	4	4	S0. CF.11	SX	DX	O 33

## RICAMBI-SPARE PARTS-RECHANGES-ERSATZTEILE-RECAMBIOS

Articolo	Descrizione	Dimensione	Prezzo
S0. CF.08	 Coltello / Knife	7,65x12x1,5	B1
S0. CF.10	 Coltello / Knife	9,6x12x1,5	B2
S0. CF.11	 Coltello / Knife	11,6x12x1,5	B3
CU. TB.01	 Cuneo / Wedge	8x12x10	A1
CU. TB.03	 Cuneo / Wedge	12x12x10	A1
VU. VQ.01	 Vite / Screw	M5x25	A55
SC. CQ.01	 Chiave / Allen Key	5X5	A35
S4. RA.01	 Rasante / Shavers	14X14x2	E14
VU. RB.01	 Vite / Screw	M5x6	G42
VU. RB.02	 Vite / Screw	M5x8	G42
SC. CT.03	 Chiave / Allen Key	T20	A30

Fresa per incastri con corpo in acciaio ad alta resistenza.  
*Grooving-Cutter with high tensile steel body.*  
 Fraise pour entailles avec corps en acier très résistant.  
*Fraeser mit koerper aus hochfestem Stahl fuer Duennnuten.*  
 Cabezal de cuchillas con cuerpo de acero a elevada resistencia.

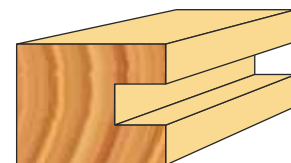



# TESTE PER TENONARE

-  - TENONING CUTTER HEADS
-  - PORTE-OUTILS A TENONNER
-  - ZAPFENMESSERKOPFE
-  - CABEZALES PARA ESIPIGAR

## TI.04

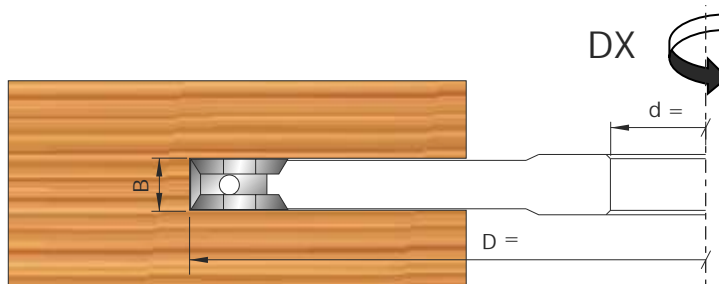
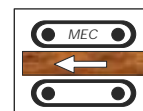





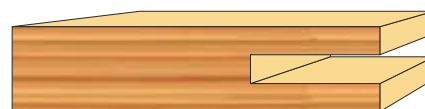









Ø	n.min.	n.max.
250	3100	6300



Articolo	D	B	d	Z	R				Prezzo
TI. 04.01	250	8	30/35/40/50	2	4	S0. CF.08	SX	DX	O 34
TI. 04.02	250	10	30/35/40/50	2	4	S0. CF.10	SX	DX	O 35
TI. 04.03	250	12	30/35/40/50	2	4	S0. CF.11	SX	DX	O 36
TI. 04.04	250	15	30/35/40/50	2	4	S0. CF.15	SX	DX	O 37
TI. 04.05	250	16	30/35/40/50	2	4	S0. CF.15	SX	DX	O 38
TI. 04.06	250	20	30/35/40/50	2	4	S0. CF.20	SX	DX	T 19
TI. 04.07	250	30	30/35/40/50	2	4	S0. CF.30	SX	DX	T 20



### RICAMBI-SPARE PARTS-RECHANGES-ERSATZTEILE-RECAMBIOS

Articolo	Descrizione	Dimensione	Prezzo
S0. CF.08	 Coltello / Knife	7,65x12x1,5	B1
S0. CF.10	 Coltello / Knife	9,6x12x1,5	B2
S0. CF.11	 Coltello / Knife	11,6x12x1,5	B3
S0. CF.15	 Coltello / Knife	15x12x1,5	B5
S0. CF.20	 Coltello / Knife	20x12x1,5	B6
S0. CF.30	 Coltello / Knife	30x12x1,5	B8
CU. TB.01	 Cuneo / Wedge	8x12x10	A1
CU. TB.03	 Cuneo / Wedge	12x12x10	A1
CU. TB.05	 Cuneo / Wedge	15x12x10	A1
CU. TB.06	 Cuneo / Wedge	20x12x10	A1
CU. TB.08	 Cuneo / Wedge	30x12x10	A1
VU. VQ.01	 Vite / Screw	M5x25	A55
SC. CQ.01	 Chiave / Allen Key	5X5	A35
VU. DS.01	 Vite / Screw	M6x18	A45
VU. OC.01	 Ogiva / Nut	M6	A46
SC. CM.02	 Chiave / Allen Key	B 3	A27

### RICAMBI-SPARE PARTS-RECHANGES-ERSATZTEILE-RECAMBIOS

Articolo	Descrizione	Dimensione	Prezzo
VU. DS.03	 Vite / Screw	M8x22	A45
VU. OC.02	 Ogiva / Nut	M8	A46
SC. CM.03	 Chiave / Allen Key	B 4	A27
S4. RT.01	 Rasante / Shavers	22.86x2.5	E19
VU. RB.01	 Vite / Screw	M5x6	G42
VU. RB.02	 Vite / Screw	M5x8	G42
SC. CT.03	 Chiave / Allen Key	T20	A30

Fresa per incastri con corpo in acciaio ad alta resistenza.



*Grooving-Cutter with high tensile steel body*

Fraise pour entailles avec corps en acier très résistant.

*Fraeser mit koerper aus hochfestem Stahl fuer Duennuten.*

Cabezal de cuchillas con cuerpo de acero a elevada resistencia

# TESTA PER SEDE GUARNIZIONE

-  - CUTTER HEAD FOR THE WEATHER STRIP GROOVE
-  - PORTE-OUTIL POUR L'ENTAILLAGE DU LOGEMENT POUR LA GARNITURE
-  - MESSERKOPF FÜR DEN DICHTUNGSITZ
-  - CABEZAL PARA LA GOMA



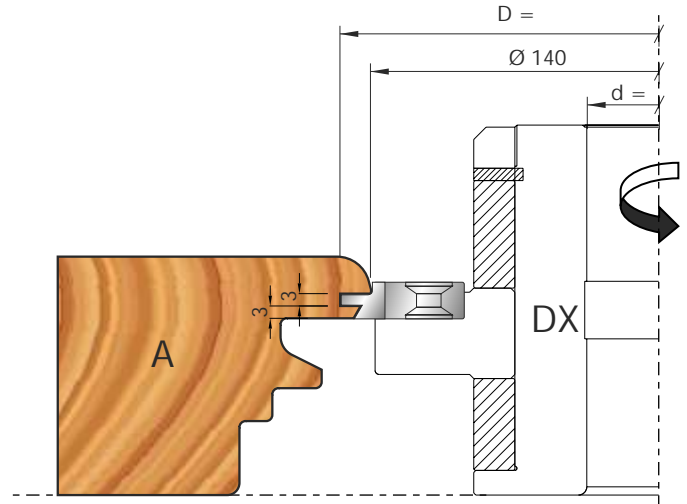
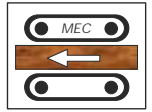

**TI.05**

Ø	n.min.	n.max.
155		8400
170		8000



Articolo	D	B	d	Z	RIF	↶	↷	Prezzo
TI. 05.01	155	40	30/35/40/50	2	A		DX	Ø 39
TI. 05.02	170	40	30/35/40/50	2	B		DX	Ø 26

## RICAMBI-SPARE PARTS-RECHANGES-ERSATZTEILE-RECAMBIOS

Articolo	Descrizione	Dimensione	Prezzo
S5. SG.03	 Settore / Sectors	32,7x16x10	V49
S5. ST.01	 Settore / Sectors	28x18x11	E40
VU. VS.02	 Vite / Screw	M6x15	A44
SC. CM.03	 Chiave / Allen Key	B 4	A27

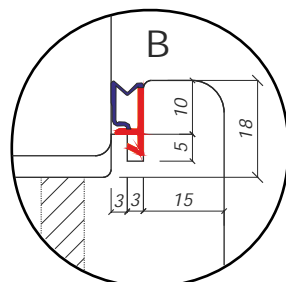
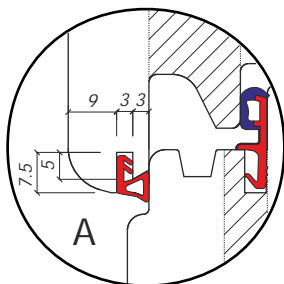
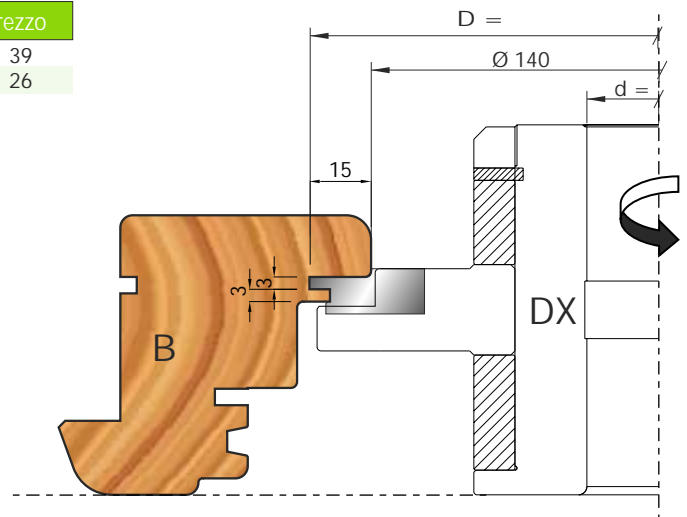

L'utensile esegue contemporaneamente la profilatura e la sede per la guarnizione

*The tool executes at the same time the profiling and the weather strip groove.*

Le porte-outils exécute en même temps le profilage et l'entaillage du logement pour la garniture.

*Das Werkzeug bearbeitet gleichzeitig das Profil und den Sitz für die Dichtung.*

La herramienta hace contemporaneamente el perfilado y la ranura para la goma.

# TESTA PER SEDE FERRAMENTA

-  - TENONING CUTTER HEADS
-  - PORTE-OUTILS A TENONNER
-  - ZAPFENMESSERKOPFE
-  - CABEZALES PARA ESPIGAR

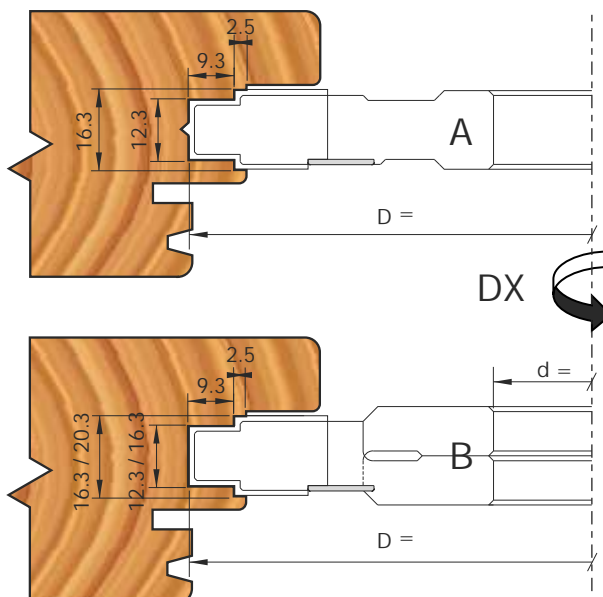
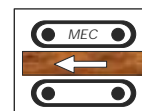

## TI.06

Ø	n.min.	n.max.
199,6		7400



Articolo	D	B	d	Z	RIF	↶	↷	Prezzo
TI. 06.01	199.6	16.3	30/35/40/50	2	A	SX	DX	O 40
TI. 06.02	199.6	16.3 > 20.3	30/35/40/50	4	B	SX	DX	O 41

### RICAMBI-SPARE PARTS-RECHANGES-ERSATZTEILE-RECAMBIOS

Articolo	Descrizione	Dimensione	Prezzo
CU. 04144PD65	 Cuneo / Wedge	16,6x30x10 DX	H9
VU. DS.03	 Vite / Screw	M8x22	A45
VU. OP.01	 Ogiva / Nut	M8	A47
SC. CM.03	 Chiave / Allen Key	B 4	A27

B = Gruppo di due frese regolabili con anelli per ricavare la sede in cui alloggiare la ferramenta per le finestre ad apertura anta-ribalta.

B = Group of two cutterheads adjustable by means of spacer rings for cutting grooves to fit window closure fitting systems

B = Jeu de deux têtes réglables par bagues pour fraiser le logement des ferrures de fenêtres.

B = Universal-Wendeplatten-Kantengetriebefräser zweiteilig verstellbar durch Zwischenringe. Zum fräsen der Fensternuten für Drehkippschläge.

B = Grupo de dos fresas estensibles con anillos para realizar la sede para el herraje de las ventanas.



S6. 03585PD65  
List. F28





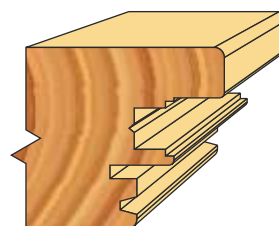

S6. 04144PD65  
List. F28





# FRESA PER INCASTRI (LAMELLO)

-  - GROOVE CUTTER (LAMELLO)
-  - FRAISE POUR ENTAILLES (LAMELLO)
-  - NUTFRAESER (LAMELLO)
-  - FRESA PARA ENSAMBLES (LAMELA)

TI.07

Ø	n.min.	n.max.
100	7600	10500

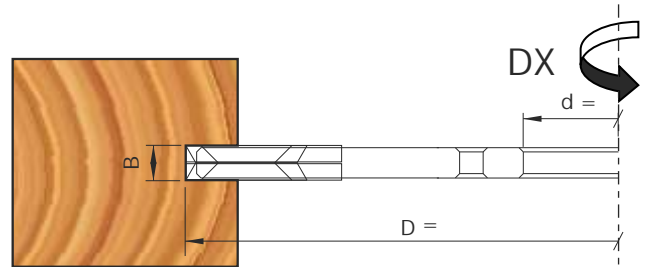
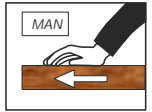

Articolo	D	B	d	Z	R	↶	↷	Prezzo
TI. 07.01	100	4	22	4	4	SX	DX	O 42

## RICAMBI-SPARE PARTS-RECHANGES-ERSATZTEILE-RECAMBIOS

Articolo	Descrizione	Dimensione	Prezzo
S0. CT.01	 Coltello / Knife	18x18x1,9	B54
S4. RA.01	 Rasante / Shavers	14x14x2	E14
VU. RF.02	 Vite / Screw	M4x1,8 B	A41
VU. RF.03	 Vite / Screw	M4x1,8 C	A41
VU. CT.01	 Vite / Screw	M4x3,2	G44
SC. CT.01	 Chiave / Allen Key	T09	A30

Fresa per ricavare gli incastri a mezzo delle fresatrici manuali tipo Lamello.

*Cutterheads to produce grooves by means of manual milling machines Lamello type.*



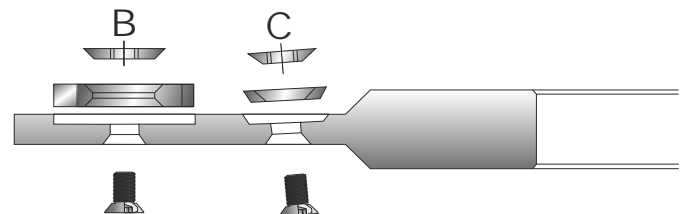
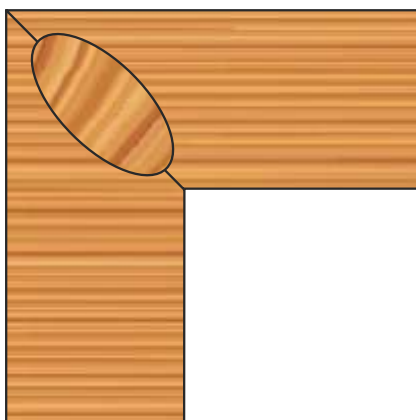

Tête pour fraiser assemblages sur machines portables type Lamello.

*Fräskopf zum Nutfräsen mittels handfräsmaschinen typ Lamello.*

Cabezal de cuchillas intercambiables pra trabajar con fresadoras portatiles para realizar ranuras de Lamello.



# FRESA PER INCASTRI SOTTILI A SPESSORE FISSO

-  - GROOVING CUTTERS THIN WITH FIX THICKNESS
-  - PORTE-OUTILS A RAINIER FIXE AVEC PETIT EPAISSEUR
-  - VORSCHNEID-NUTFRAESER FUER DUENNUTEN
-  - FRESA DE RANURA FISA DE POCO ESPESSOR CON PRECORTADORES

TI.08

Ø	n.min.	n.max.
140	5500	8800
180	4200	7800

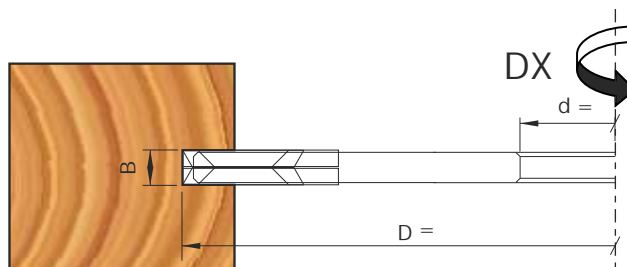
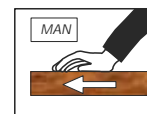

Articolo	D	B	d	Z	R				Prezzo
TI. 08.01	140	4	30/35/40/50	4	4	S0. CT.01	SX	DX	O 43
TI. 08.02	140	5	30/35/40/50	4	4	S0. CT.02	SX	DX	O 44
TI. 08.03	140	6	30/35/40/50	4	4	S0. CT.02	SX	DX	O 45
TI. 08.04	180	4	30/35/40/50	4	4	S0. CT.01	SX	DX	O 46
TI. 08.05	180	5	30/35/40/50	4	4	S0. CT.02	SX	DX	O 47
TI. 08.06	180	6	30/35/40/50	4	4	S0. CT.02	SX	DX	O 48

## RICAMBI-SPARE PARTS-RECHANGES-ERSATZTEILE-RECAMBIOS

Articolo	Descrizione	Dimensione	Prezzo
S0. CT.01	 Coltello / Knife	18x18x1,9	B54
S0. CT.02	 Coltello / Knife	18x18x2,9	B55
VU. RF.01	 Vite / Screw	M4x2,7 A	A41
VU. RF.02	 Vite / Screw	M4x1,8 B	A41
VU. RF.03	 Vite / Screw	M4x1,8 C	A41
VU. CT.01	 Vite / Screw	M4x3,2	G44
VU. CT.02	 Vite / Screw	M4x4	G44
SC. CT.01	 Chiave / Allen Key	T09	A30
S4. RA.01	 Rasante / Shavers	14x14x2	E14

Fresa per incastri sottili con corpo in acciaio ad alta resistenza.

*Grooving cutter thin, with high tensile steel body*

Fraise pour entailles avec petit epaisseur avec corps en acier très résistant.

*Fraeser mit koerper aus hochfestem Stahl fuer Duennuten.*

Cabezal de cuchillas de poco espesor con cuerpo de acero a elevada resistencia.

