

FRESE PER TELAI E SQUADRATURA DI PORTE



- SQUARING DOOR FRAME CUTTERS
- FRAISES POUR CHÂSSIS POUR ÉQUARRISSAGE DE PORTES
- TUERRAHMENFRAESER TUERBESCHLAGUNG
- FRESAS PARA MARCOS PARA LA ESCUADRERÍA DE PUERTAS

TE







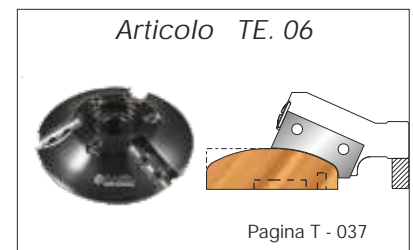
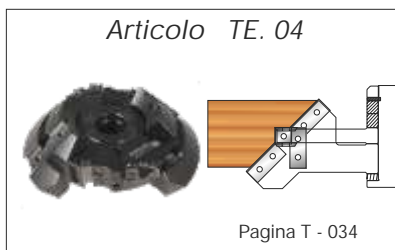

Foto by Arredo Bar Tonolli (Brentonico TN)

NOTE

FRESE PER TELAI DI PORTE

-  - DOOR FRAME CUTTERS
-  - FRAISES POUR CHÂSSIS DE PORTES
-  - TUERRAHMENFRAESER
-  - FRESAS PARA MARCOS DE PUERTAS

TE.01



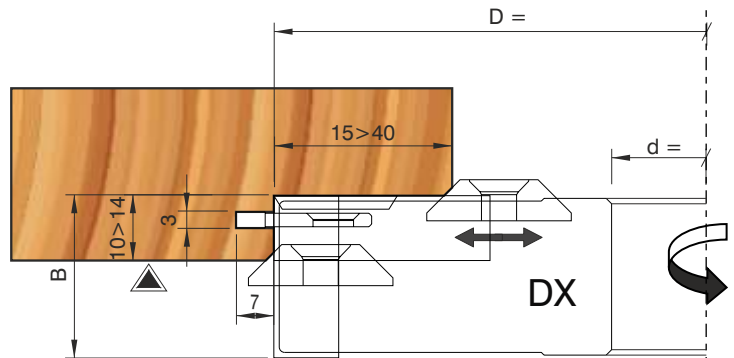
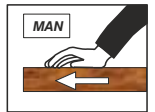
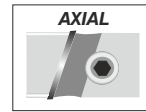





Ø	n.min.	n.max.
200	3800	7400



Articolo	D	B	d	Z	R	S	T	↔	↷	Prezzo
TE. 01.01	200	30	30/35/40/50	2+2	2	2	2		DX	M 37



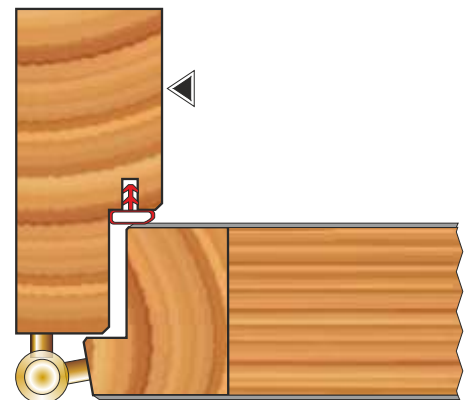
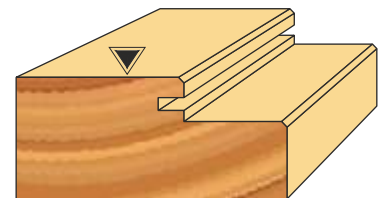

Fresa con coltelli reversibili standard.
Cutters with standard reversible knives.
Fraise à plaquettes reversibles standard.
Fraeser mit standard wendeschneidplatten.
Fresa con cuchillas reversibles standard.

RICAMBI-SPARE PARTS-RECHANGES-ERSATZTEILE-RECAMBIOS

Articolo	Descrizione	Dimensione	Prezzo
S0. CF.30	 Coltello / Knife	30x12x1.5	B8
CU. TB.08	 Cuneo / Wedge	30x12x10	A1
VU. DS.03	 Vite / Screw	M8x22	A45
VU. OC.02	 Ogiva / Nut	M8	A46
SC. CM.03	 Chiave / Allen Key	B 4	A27
S0. CF.50	 Coltello / Knife	50x12x1.5	B10
CU. TB.10	 Cuneo / Wedge	50x12x10	A1
S4. RT.01	 Rasante / Shavers	22.86x2.5	E19
VU. RB.02	 Vite / Screw	M5x8	G42
SC. CT.03	 Chiave / Allen Key	T20	A30
S7. SB.01	 Spigolatori / Chanfering	26.8x15.8 45°	F21
VU. VS.03	 Vite / Screw	M6x20.5	A44
S5. SB.03	 Settore / Sectors	25x20x3	F1
VU. VS.02	 Vite / Screw	M6x15	A44
S7. PM.03	 Supporti / Supports	Tipo C	A4
VU. GC.06	 Vite / Screw	M6x16	A37
SC. CM.02	 Chiave / Allen Key	B 3	A27



GRUPPI FRESE PER SQUADRATURA DI PORTE

-  - SET OF CUTTERS FOR SQUARING DOORS
-  - GROUPES DE FRAISES POUR ÉQUARRISSAGE DES PORTES
-  - FRAESERGRUPPEN FUER TUERBESCHLAGUNG
-  - GRUPO DE FRESAS PARA LA ESCUADERÍA DE LAS PUERTAS

TE.02

Ø	n.min.	n.max.
162	4700	8200

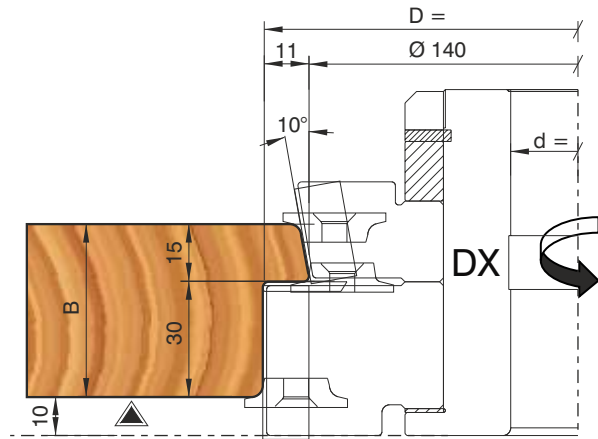
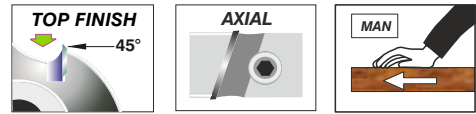

Articolo	D	B	d	Z	R	S	Profilo	↔	↷	Prezzo
TE. 02.01	162	45	30/35/40/50	2	2	2	A		DX	M 38
TE. 02.02	162	45	30/35/40/50	4	2	2	A		DX	M 39
TE. 02.03	162	45	30/35/40/50	2	2	2	B		DX	M 40
TE. 02.04	162	45	30/35/40/50	4	2	2	B		DX	M 41

Gruppo per squadratura porte montato su mozzo.

Tool set for doors squaring on sleeve.

Jeu de fraises pour le calibrage des portes montées sur manchon.

Fräsergarnitur für Türeubenprofil auf Büchse.



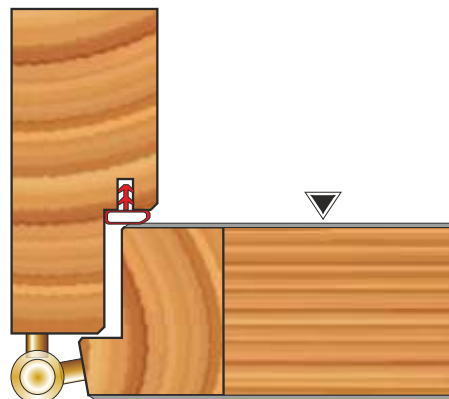
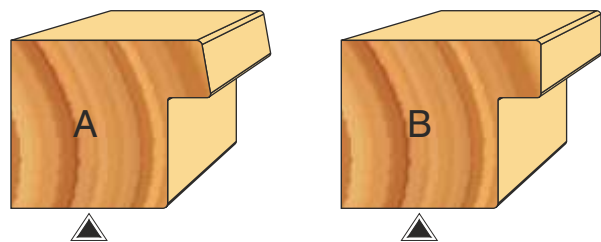

Juego de fresas para la esquadria de puertas montadas sobre manguito.

RICAMBI-SPARE PARTS-RECHANGES-ERSATZTEILE-RECAMBIOS

Articolo	Descrizione	Dimensione	Prezzo
S0. CH.25	 Coltello / Knife	25x12x1.5	B32
CU. TI.06	 Cuneo / Wedge	25x15x10	A3
S0. CH.40	 Coltello / Knife	40x12x1.5	B34
CU. TA.06	 Cuneo / Wedge	40x15x10	A2
VU. DS.03	 Vite / Screw	M8x22	A45
VU. OC.02	 Ogiva / Nut	M8	A46
SC. CM.03	 Chiave / Allen Key	B 4	A27
S4. RT.02	 Rasante / Shavers	21.9x2.5	E20
VU. RB.02	 Vite / Screw	M5x8	G42
SC. CT.03	 Chiave / Allen Key	T20	A30
S7. SB.05	 Spigolatori / Chanfering	26,8x15,8 R3	F23
S7. SB.06	 Spigolatori / Chanfering	26.8x15.8 R3	F23
S7. SB.03	 Spigolatori / Chanfering	26.8x15.8 R1.5	F22
VU. VS.02	 Vite / Screw	M6x15	A44



GRUPPI FRESE PER SQUADRATURA DI PORTE

-  - SET OF CUTTERS FOR SQUARING DOORS
-  - GROUPES DE FRAISES POUR ÉQUARRISSAGE DES PORTES
-  - FRAESERGRUPPEN FUER TUERBESCHLAGUNG
-  - GRUPO DE FRESAS PARA LA ESCUADRERÍA DE LAS PUERTAS





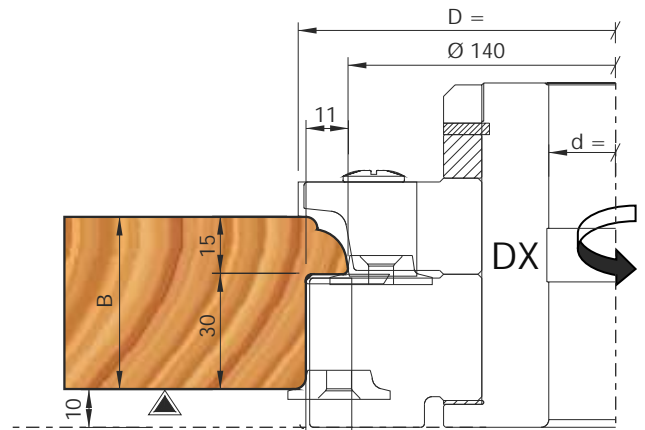
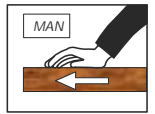
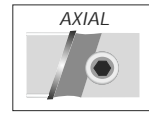
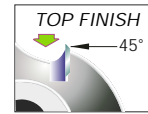



TE.03

Ø	n.min.	n.max.
166	4600	- 8100



Articolo	D	B	d	Z	R	S	↶	↷	Prezzo
TE. 03.01	166	45	30/35/40/50	2	2	2		DX	M 42
TE. 03.02	166	45	30/35/40/50	4	2	2		DX	M 43

RICAMBI-SPARE PARTS-RECHANGES-ERSATZTEILE-RECAMBIOS

Articolo	Descrizione	Dimensione	Prezzo
S0. CH.40	 Coltello / Knife	40x12x1.5	B34
CU. TA.06	 Cuneo / Wedge	40x15x10	A1
VU. DS.03	 Vite / Screw	M8x22	A45
VU. OC.02	 Ogiva / Nut	M8	A46
SC. CM.03	 Chiave / Allen Key	B 4	A27
S4. RT.02	 Rasante / Shavers	21.9x2.5	E20
VU. RB.02	 Vite / Screw	M5x8	G42
SC. CT.03	 Chiave / Allen Key	T20	A30
S7. SB.03	 Spigolatori / Chanfering	26.8x15.8 R1.5	F22
S7. SB.05	 Spigolatori / Chanfering	26.8x15.8 R3	F23
VU. VS.02	 Vite / Screw	M6x15	A44
CU. 04120PS06	 Cuneo / Wedge	25x35x10 SX	H9
VU. DS.04	 Vite / Screw	M10x22	A45
VU. OP.02	 Ogiva / Nut	M10	A47
SC. CM.04	 Chiave / Allen Key	B 5	A27

Gruppo per squadratura porte montato su mozzo. In fase di ordinazione va specificato il profilo desiderato indicando il relativo codice del coltellino.

Tool set for doors squaring on sleeve. When ordering, please specify desired profile indicating the relative knife code.



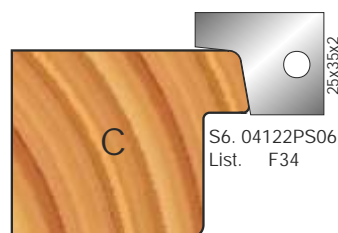
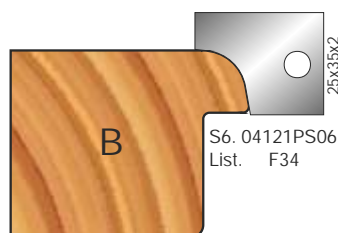
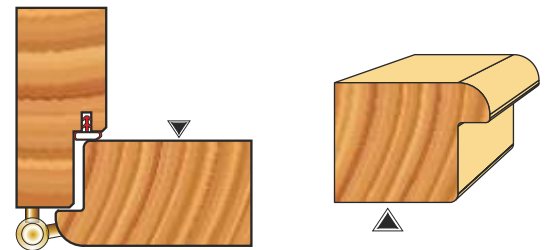

Jeu de fraises pour le calibrage des portes montées sur manchon. Lors de la commande, il est nécessaire de préciser le profil désiré, en indiquant la référence des couteaux.

Fräsergarnitur für Türeubenprofil auf Büchse. Im Falle eines Auftrags bitten wir, das gewünschte Profil mit dem entsprechenden Messer-Code anzugeben.

Juego de fresas para la esquadria de puertas montadas sobre manguito. Al realizar un pedido, por favor especificar perfil deseado indicando el código de cuchilla correspondiente.



FRESE PER GIUNZIONI A 45° PER TELAI DI PORTE

-  - CUTTERS FOR JOINTS WITH 45° FOR DOOR FRAMES
-  - FRAISE POUR ASSEMBLAGES À 45° POUR CHÂSSIS DE PORTES
-  - FRÄSER FÜR VERBINDUNGEN ZU 45° FÜR DREITEILIGE TUERRAHMEN
-  - FRESA PARA ASEMBLAJES DE 45° PARA MARCOS DE PUERTAS

TE.04

Ø	n.min.	n.max.
230	3300	6900

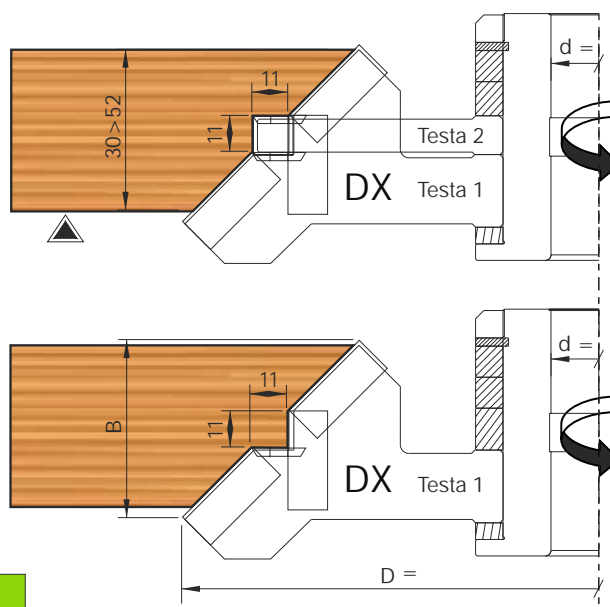
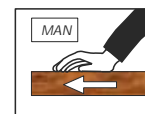

Articolo	D	B	d	Z	R	↶	↷	Prezzo
TE. 04.01	230	52	30/35/40/50	2	2		DX	M 44

RICAMBI-SPARE PARTS-RECHANGES-ERSATZTEILE-RECAMBIOS

Articolo	Descrizione	Dimensione	Prezzo
S0. CF.30	 Coltello / Knife	30x12x1.5	B8
CU. TB.08	 Cuneo / Wedge	30x12x10	A1
VU. DS.03	 Vite / Screw	M8x22	A45
VU. OC.02	 Ogiva / Nut	M8	A46
SC. CM.03	 Chiave / Allen Key	B 4	A27
S0. CF.12	 Coltello / Knife	12x12x1.5	B4
CU. TB.04	 Cuneo / Wedge	12x12x10	A1
VU. DS.01	 Vite / Screw	M6x18	A45
VU. OC.01	 Ogiva / Nut	M6	A46
SC. CM.02	 Chiave / Allen Key	B 3	A27
S4. RA.01	 Rasante / Shavers	14x14x2	E14
VU. RB.02	 Vite / Screw	M5x8	G42
SC. CT.03	 Chiave / Allen Key	T20	A30

Gruppo frese per giunzioni a 45° per telai di porte composto da 2 elementi.

Group of 45° joint cutters for door frames - composed of 2 elements.



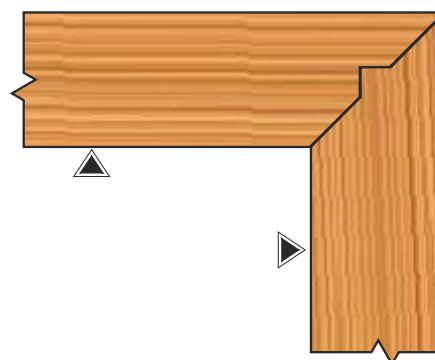

Groupe de fraises pour assemblages à 45°, pour châssis de portes. Il est composé de 2 éléments.

Fraesergruppen fuer Verbindungen zu 45° fuer zweiteilige Tuerrahmen.

Grupo de fresas para juntas a 45° para marcos de puertas compuesto de 2 elementos.



GRUPPI FRESE PER TELAIO REGOLABILE

-  - SETS OF ADJUSTABLE FRAME CUTTERS
-  - GROUPES DE FRAISES POUR CHÂSSIS RÉGLABLE
-  - FRAESERGRUPPEN FUER EINSTELLBAREN RAHMEN
-  - GRUPO DE FRESAS PARA MARCO REGULABLE

TE.05

Ø	n.min.	n.max.
150	5100	- 8500
160	4800	- 8300
182	4200	- 7800

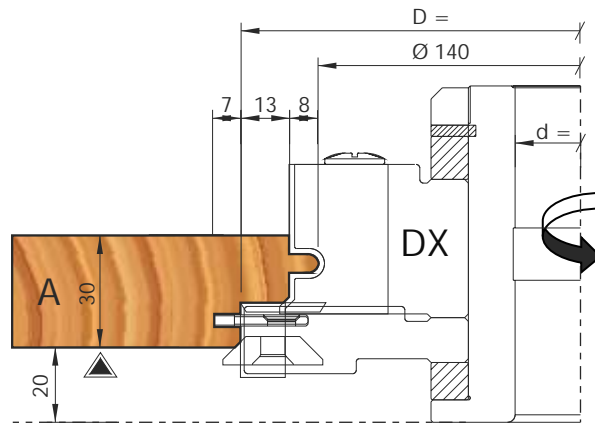
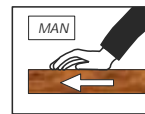
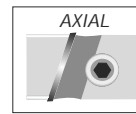
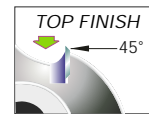

Articolo	D	B	d	Z	R	S	T	Profilo	↶	↷	Prezzo
TE. 05.01	182	55	30/35/40/50	2	2	2	2	A	DX	M	45
TE. 05.02	160	55	30/35/40/50	2	2	2	2	B	DX	M	46
TE. 05.03	150	80	30/35/40/50	2	2	2	2	C	DX	M	47

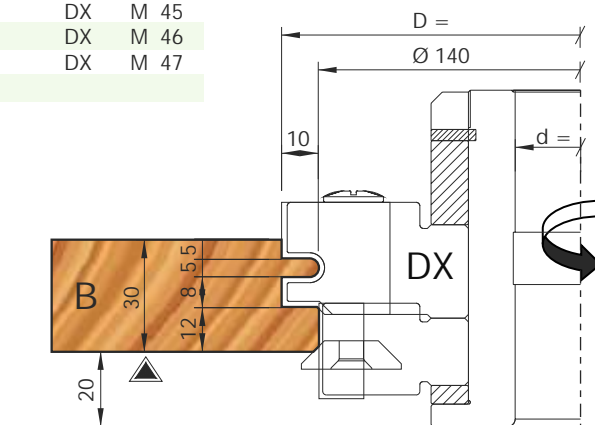

Gruppi frese per ottenere un telaio regolabile tramite l'incastro delle mostrine coprifilo con il telaio stesso.

Set Tools to obtaining a frame which can be regulated by means of the joint between the wire cover moulding and the frame itself.



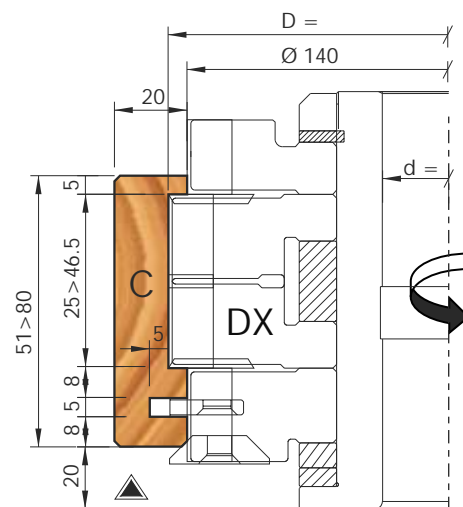
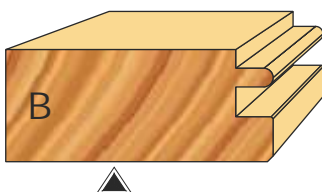
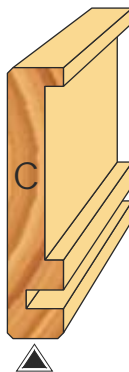
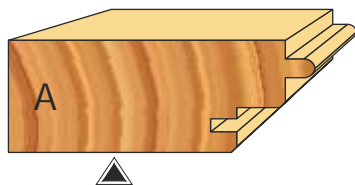

Groupes de fraises pour obtenir un châssis réglable par l'entaille des éléments couvre-fil et le châssis même.

Fräsergruppe für herstellung von einstellbaren rahmen durch vernutung der kabelabdeckleiste mit dem rahmen selbst.

Grupo de fresas por obtener un marco regulable a traico de las juntas del perfil del tapajuntas con el del marco.



GRUPPI FRESE PER TELAIO REGOLABILE



-  - SETS OF ADJUSTABLE FRAME CUTTERS
-  - GROUPES DE FRAISES POUR CHÂSSIS RÉGLABLE
-  - FRAESERGRUPPEN FUER EINSTELLBAREN RAHMEN
-  - GRUPO DE FRESAS PARA MARCO REGULABLE

TE.05

- Esempi di lavorazione.
- Examples of processing.
- Exemples d'usinages.
- Anwendungs-beispiele.
- Ejemplo de trabajos.



RICAMBI-SPARE PARTS-RECHANGES-ERSATZTEILE-RECAMBIOS

Articolo	Descrizione	Dimensione	Prezzo
S0. CH.20	 Coltello / Knife	20x12x1.5	B31
CU. TI.03	 Cuneo / Wedge	20x15x10	A3
CU. TI.04	 Cuneo / Wedge	20x15x10	A3
S0. CH.25	 Coltello / Knife	25x12x1.5	B32
CU. TI.06	 Cuneo / Wedge	25x15x10	A3
CU. TA.04	 Cuneo / Wedge	25x15x10	A2
VU. DS.03	 Vite / Screw	M8x22	A45
VU. OC.02	 Ogiva / Nut	M8	A46
SC. CM.03	 Chiave / Allen Key	B 4	A27
S4. RT.01	 Rasante / Shavers	22.86x2.5	E19
VU. RB.02	 Vite / Screw	M5x8	G42
SC. CT.03	 Chiave / Allen Key	T20	A30
S5. SB.05	 Settore / Sectors	25x20x5	F3
S5. SB.03	 Settore / Sectors	25x20x3	F1
S7. SB.01	 Spigolatori / Chanfering	26.8x15.8 45°	F21
VU. VS.02	 Vite / Screw	M6x15	A44
CU.04118PS16	 Cuneo / Wedge	40x30x10 SX	H9
CU.04119PS08	 Cuneo / Wedge	30x30x10 SX	H9
VU. DS.04	 Vite / Screw	M10x22	A45
VU. OP.02	 Ogiva / Nut	M10	A47
SC. CM.04	 Chiave / Allen Key	B 5	A27

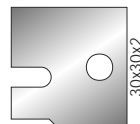

S6. 04119PS08
List. F37

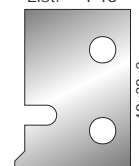

S6. 04118PS16
List. F46



FRESE PER TELAI DI PORTE "ELISSE"

-  - DOOR FRAME CUTTERS "ELISSE"
-  - FRAISES POUR CHÂSSIS DE PORTES "ELISSE"
-  - TUERRAHMENFRAESER "ELISSE"
-  - FRESAS PARA MARCOS DE PUERTAS "ELISSE"

TE.06

Ø	n.min.	n.max.
200	3800	7400
221	3500	7000

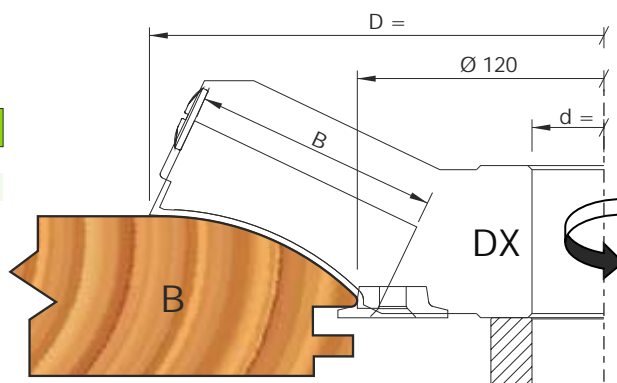
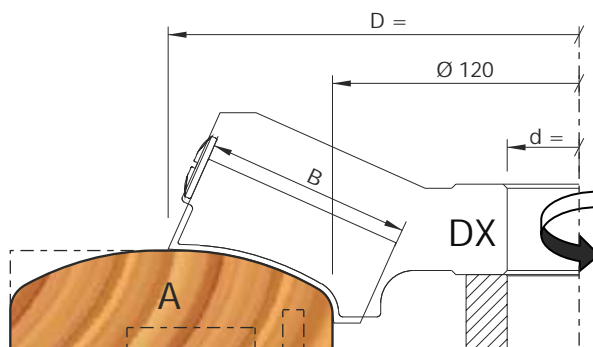
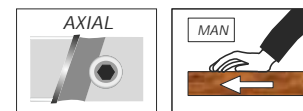

Articolo	D	B	d	Z	Profilo	↶	↷	Prezzo
TE. 06.01	200	50	30/35/40/50	3	A		DX	M 48
TE. 06.02	221	60	30/35/40/50	3	B		DX	M 49

RICAMBI-SPARE PARTS-RECHANGES-ERSATZTEILE-RECAMBIOS

Articolo	Descrizione	Dimensione	Prezzo
Per testa/ for head Profilo A			
CU. 04130PS22	 Cuneo / Wedge	50x25x10 SX	H9
VU. DS.04	 Vite / Screw	M10x22	A45
VU. OP.02	 Ogiva / Nut	M10	A47
SC. CM.04	 Chiave / Allen Key	B 5	A27
Per testa/ for head Profilo B			
CU. 04131PS30	 Cuneo / Wedge	60x25x10 SX	H9
VU. DS.04	 Vite / Screw	M10x22	A45
VU. OP.02	 Ogiva / Nut	M10	A47
SC. CM.04	 Chiave / Allen Key	B 5	A27
S7. SB.03	 Spigolatori / Chanfering	26.8x15.8 R1.5	F22
VU. VS.02	 Vite / Screw	M6x15	A44
SC. CM.03	 Chiave / Allen Key	B 4	A27

Gruppi frese per ottenere un telaio regolabile tramite l'incastro delle mostrine coprifilo con il telaio stesso.

Set Tools to obtaining a frame which can be regulated by means of the joint between the wire cover moulding and the frame itself.



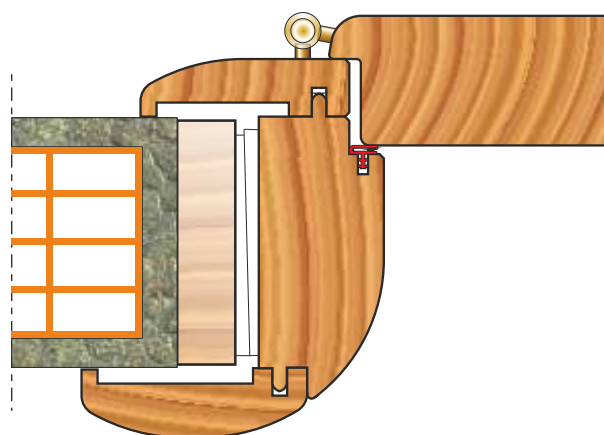
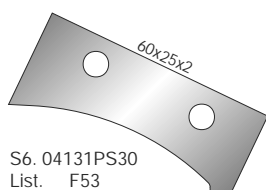
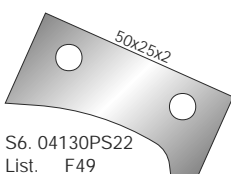

Groupes de fraises pour obtenir un châssis réglable par l'entaille des éléments couvre-fil et le châssis même.

Fräsergruppe für herstellung von einstellbaren rahmen durch vernutung der kabelabdeckleiste mit dem rahmen selbst.

Grupo de fresas por obtener un marco regulable a traico de las juntas del perfil del tapajuntas con el del marco.



IL LAVORO LA NOSTRA PASSIONE

-  - *WORK OUR PASSION*
-  - *TRAVAILLER NOTRE PASSION*
-  - *ARBEIT UNSERE LEIDENSCHAFT*
-  - *TRABAJAR NUESTRA PASIÓN*

