









TESTE PER CONTORNARE

-  - JOINTING AND REBATING CUTTERHEAD
-  - PORTE-OUTILS À CALIBRER
-  - FÜGEFRÄSER
-  - CABEZAL PARA CONTORNEAR

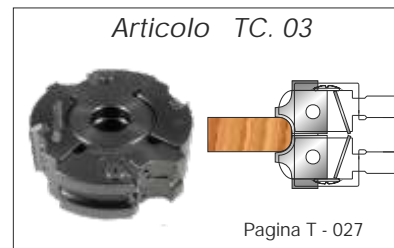
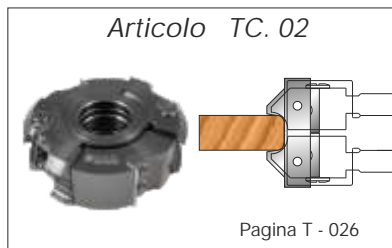
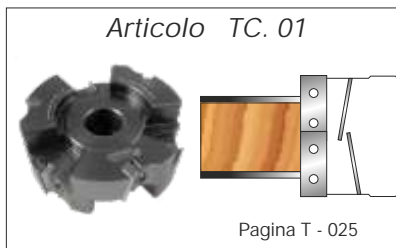
TC



FRESA CON COLTELLI ALTERNATIVAMENTE INCLINATI

-  - JOINTING CUTTERHEAD WITH ALTERNATE SET KNIVES
-  - FRAISES AVEC LAMES MONTÉES ALTERNATIVEMENT ET INCLINÉES
-  - WENDEPLATTEN-FÜGEKOPF
-  - CABEZAL DE CUCHILLAS INTERCAMBIABLES CORTES ALTERNATIVOS

TC.01

Ø	n.min.	n.max.
125	6100	9400
150	5100	8500
180	4200	7800

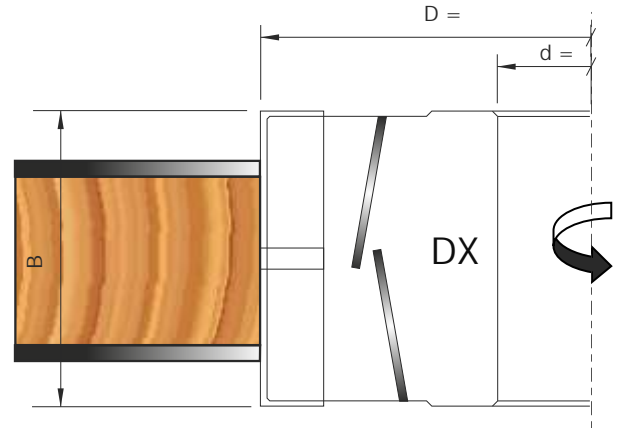
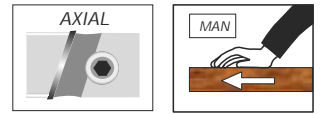

Articolo	D	B	d	Z	↶	↷	Prezzo
TC. 01.01	125	56	30/35/40/50	2+2	SX	DX	M 26
TC. 01.02	125	56	30/35/40/50	3+3	SX	DX	M 27
TC. 01.03	150	56	30/35/40/50	2+2	SX	DX	M 28
TC. 01.04	150	56	30/35/40/50	3+3	SX	DX	M 29
TC. 01.05	180	56	30/35/40/50	3+3	SX	DX	M 30

RICAMBI-SPARE PARTS-RECHANGES-ERSATZTEILE-RECAMBIOS

Articolo	Descrizione	Dimensione	Prezzo
S0. CM.30	 Coltello / Knife	30x12x1.5	B44
CU. TB.08	 Cuneo / Wedge	30x12x10	A1
VU. DS.03	 Vite / Screw	M8x22	A45
VU. OC.02	 Ogiva / Nut	M8	A46
SC. CM.03	 Chiave / Allen Key	B 4	A27

Adatta per la lavorazione di pannelli laminati o impiallacciati su uno o due lati. Il taglio inclinato verso l'interno evita la scheggiatura sul laminato.



Designed for jointing or copy-shaping of board materials veneered or laminated on both sides. Knives shearing outside to inside prevent tearouts or splintering of edges.

Particulièrement adaptée au travail de panneaux laminés ou plaqués. La coupe inclinée vers l'intérieur empêche de faire éclater les arêtes.

Konstruktion mit von außen nach innen ziehendem Schnitt (Achswinkel). Geeignet zum Fügen und Kopierfräsen von beidseitig furnierten oder kunststoffbeschichteten Platten. Durch geteilten und ziehenden Schnitt wird ein Ausreißen der Kanten verhindert.

Recomendada para la mecanización de tableros laminados en uno ó en ambas superficies. El corte inclinado hacia el interior evita resquebraduras en el laminado.

FRESE PIANE PER CONTORNARE CON LEVASPIGOLI 45°/ RAGGIO

-  - JOINTING CUTTERHEADS WITH CORNER REMOVERS AT 45° OR RADIUS
-  - PORTE-OUTILS A RABOTER ET DRESSER AVEC SUPPRIMEANGLES À 45° OU RADIES
-  - FUGE-MESSERKOPFE MIT ENTKANTERN ZU 45° ODER RADIAL
-  - FRESA CORTE RECTO PAR CONTORNEAR CON ACHAFLANADORES A 45° O CON RADIO

TC.02

Ø	n.min.	n.max.
140		8800
155		8400

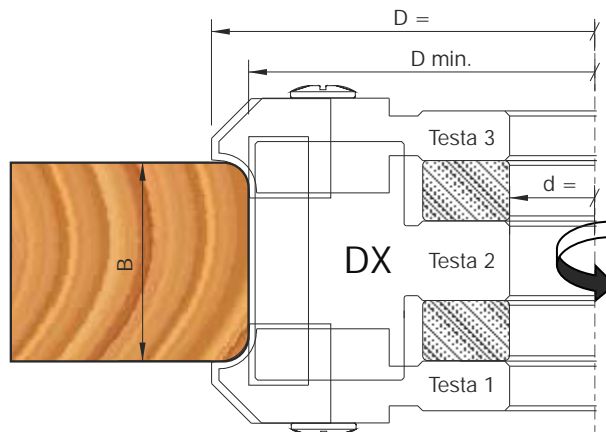
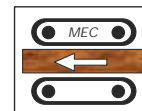

Articolo	D	D.min	B	d	Z	↶	↷	Prezzo
TC. 02.01	140	125	55	30/35/40	2	SX	DX	M 31
TC. 02.02	155	140	55	30/35/40/50	2	SX	DX	M 32

L'utensile viene fornito completo di una serie di coltelli per il raggio richiesto. (R= 2 - 3 - 4 - 5 - 6)

The tool is supplied complete with a set of knives for cutting the radius required. (R= 2 - 3 - 4 - 5 - 6)

Le port-outils vient livré complete avec en jru de plaquettes pour le rayon demandé. (R= 2 - 3 - 4 - 5 - 6)

Das Werkzeug wird mit den Messern der gewünschten Radien geliefert. (R= 2 - 3 - 4 - 5 - 6)

La herramienta se suministra con una serie de cuchillas para el radio desedeado. (R= 2 - 3 - 4 - 5 - 6)

RICAMBI-SPARE PARTS-RECHANGES-ERSATZTEILE-RECAMBIOS

Articolo	Descrizione	Dimensione	Prezzo
S0. CF.50	 Coltello / Knife	50x12x1.5	B10
CU. TB.10	 Cuneo / Wedge	50x12x10	A1
VU. DS.03	 Vite / Screw	M8x22	A45
VU. OC.02	 Ogiva / Nut	M8	A46
CU. 02750PD01	 Cuneo / Wedge	20x25x10 DX	H9
CU. 02750PS01	 Cuneo / Wedge	20x25x10 SX	H9
VU. DS.03	 Vite / Screw	M8x22	A45
VU. OP.01	 Ogiva / Nut	M8	A47
SC. CM.03	 Chiave / Allen Key	B 4	A27

- Esempi di lavorazione.
- Examples of processing.
- Exemples d'usinages.
- Anwendungs-beispiele.
- Ejemplo de trabajos.

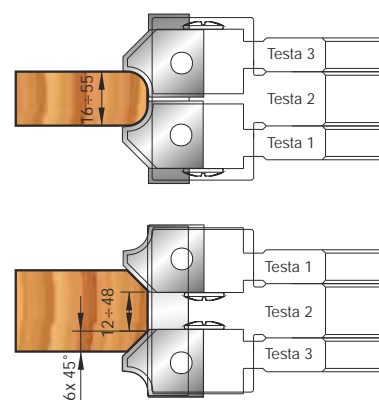

S6. 02750PD01
List. F29



S6. 02751PD01
List. F29

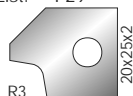

S6. 02752PD01
List. F29

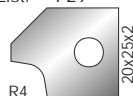

S6. 02753PD01
List. F29

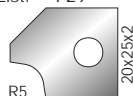

S6. 02754PD01
List. F29

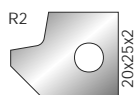
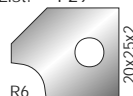

S6. 02750PS01
List. F29

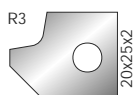

S6. 02751PS01
List. F29

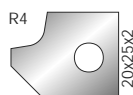

S6. 02752PS01
List. F29

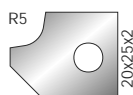

S6. 02753PS01
List. F29

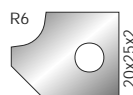

S6. 02754PS01
List. F29

FRESE PIANE PER CONTORNARE CON LEVASPIGOLI A 45°/RAGGIO

-  - JOINTING CUTTERHEADS WITH CORNER REMOVERS AT 45° OR RADIUS
-  - PORTE-OUTILS A RABOTER ET DRESSER AVEC SUPPRIMEANGLES À 45° OU RADIES
-  - FUGE-MESSERKOPFE MIT ENTKANTERN ZU 45° ODER RADIAL
-  - FRESA CORTE RECTO PAR CONTORNEAR CON ACHAFLANADORES A 45° O CON RADIO

TC.03

Ø	n.min.	n.max.
140		8800
155		8400

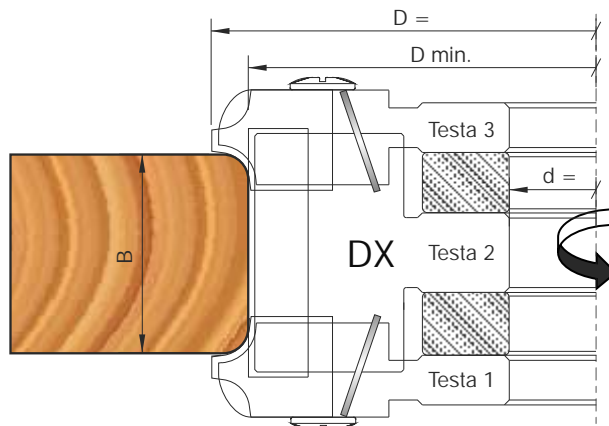
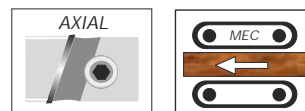

Articolo	D	D.min	B	d	Z	↺	↻	Prezzo
TC. 03.01	140	125	55	30/35/40	2	SX	DX	M 33
TC. 03.02	155	140	55	30/35/40/50	2	SX	DX	M 34

RICAMBI-SPARE PARTS-RECHANGES-ERSATZTEILE-RECAMBIOS

Articolo	Descrizione	Dimensione	Prezzo
S0. CF.50	 Coltello / Knife	50x12x1.5	B10
CU. TB.10	 Cuneo / Wedge	50x12x10	A1
VU. DS.03	 Vite / Screw	M8x22	A45
VU. OC.02	 Ogiva / Nut	M8	A46
CU. 04110PD01	 Cuneo / Wedge	20x25x10 DX	H9
CU. 04110PS01	 Cuneo / Wedge	20x25x10 SX	H9
VU. DS.03	 Vite / Screw	M8x22	A45
VU. OP.01	 Ogiva / Nut	M8	A47
SC. CM.03	 Chiave / Allen Key	B 4	A27

L'utensile viene fornito completo di una serie di coltelli per il raggio richiesto. (R= 2 - 3 - 4 - 5 - 6)

The tool is supplied complete with a set of knives for cutting the radius required. (R= 2 - 3 - 4 - 5 - 6)

Le port-outils vient livré complete avec en jru de plaquettes pour le rayon demandé. (R= 2 - 3 - 4 - 5 - 6)

Das Werkzeug wird mit den Messern der gewünschten Radien geliefert (R= 2 - 3 - 4 - 5 - 6).

La herramienta se suministra con una serie de cuchillas para el radio deseadado. (R= 2 - 3 - 4 - 5 - 6)

- Esempi di lavorazione.
- Examples of processing.
- Exemples d'usages.
- Anwendungs-beispiele.
- Ejemplo de trabajos.

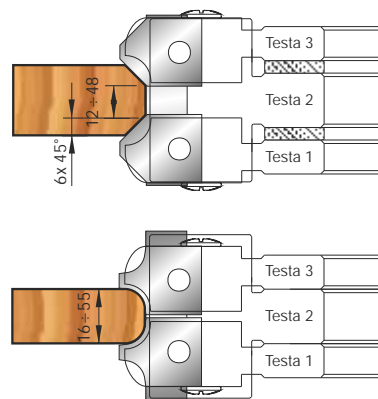

S6. 04110PD01
List. F29



S6. 04111PD01
List. F29

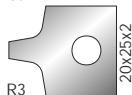

S6. 04112PD01
List. F29



S6. 04113PD01
List. F29



S6. 04114PD01
List. F29

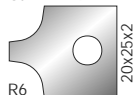

S6. 04115PD01
List. F29

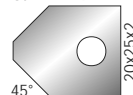

FRESE PIANE PER CONTORNARE CON LEVASPIGOLI 45°/ RAGGIO

-  - JOINTING CUTTERHEADS WITH CORNER REMOVERS AT 45° OR RADIUS
-  - PORTE-OUTILS A RABOTER ET DRESSER AVEC SUPPRIMEANGLES À 45° OU RADIES
-  - FUGE-MESSERKOPFE MIT ENTKANTERN ZU 45° ODER RADIAL
-  - FRESA CORTE RECTO PAR CONTORNEAR CON ACHAFLANADORES A 45° O CON RADIO

TC.04

Ø	n.min.	n.max.
125	6100	9400
140	5500	8800

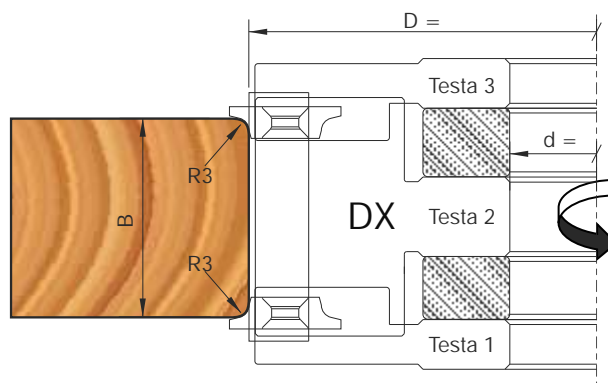
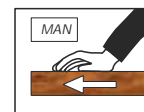

Articolo	D	B	d	Z	↶	↷	Prezzo
TC. 04.01	125	55	30/35/40	2	SX	DX	M 35
TC. 04.02	140	55	30/35/40/50	2	SX	DX	M 36

Set composto da tre elementi registrabili mediante anelli. Teste fornite con il raggio 3, a richiesta vengono fornite con raggio 1.5 - 2 - 4.5 - o spigolatori 45°.

















The set is composed of three tools, which are adjustable thanks to spacer rings. The tool sets are supplied with radius 3, on request with radius 1.5 - 2 - 4.5 - or with chamfering knives 45°.

Jet de fraises composé par trois éléments extensibles grâce aux bagues d'écartement. Ils sont vendus avec rayon 3, sur demande avec rayon 1.5 - 2 - 4.5 - ou plaquettes à chanfrainer 45°.

Die Garnitur besteht aus drei Werkzeugen die durch Distanzringe verstellbar sind. Die Garnitur wird mit Radius 3 geliefert, auf Wunsch mit radius 1.5 - 2 - 4.5 - oder mit Kantenbrechern 45°.

El juego de fresas se compone de tres elementos extensibles con anillos intermedios. Los juegos se ofrecen con el radio 3, bajo pedido con radio 1.5 - 2 - 4.5 - o cuchillas para cantea 45°.

RICAMBI-SPARE PARTS-RECHANGES-ERSATZTEILE-RECAMBIOS

Articolo	Descrizione	Dimensione	Prezzo
S0. CF.50	 Coltello / Knife	50x12x1.5	B10
CU. TB.10	 Cuneo / Wedge	50x12x10	A1
VU. DS.03	 Vite / Screw	M8x22	A45
VU. OC.02	 Ogiva / Nut	M8	A46
S7. SB.01	 Spigolatori / Chanfering	26.8x15.8 45°	F21
S7. SB.02	 Spigolatori / Chanfering	26.8x15.8 45°	F21
S7. SB.03	 Spigolatori / Chanfering	26.8x15.8 R1.5	F22
S7. SB.04	 Spigolatori / Chanfering	26.8x15.8 R1.5	F22
S7. SB.11	 Spigolatori / Chanfering	26.8x15.8 R2	F22
S7. SB.12	 Spigolatori / Chanfering	26.8x15.8 R2	F22
S7. SB.05	 Spigolatori / Chanfering	26.8x15.8 R3	F23
S7. SB.06	 Spigolatori / Chanfering	26.8x15.8 R3	F23
S7. SB.07	 Spigolatori / Chanfering	26.8x15.8 R4.5	F24
S7. SB.08	 Spigolatori / Chanfering	26.8x15.8 R4.5	F24
VU. VS.02	 Vite / Screw	M6x15	A44
SC. CM.03	 Chiave / Allen Key	B 4	A27

