

# TESTE PER ANTINE



- CUTTERHEADS FOR SHUTTER
- PORTE-OUTILS POUR PORTES DE CUISINE
- WENDEPLATTEN KONTERPROFIL MESSER KOPF
- JUEGO DE CABEZAL DE MOLDURA E CONTROMOLDURA

TA

Articolo TA. 01



Articolo TA. 02



Articolo TA. 03



Articolo TA. 04

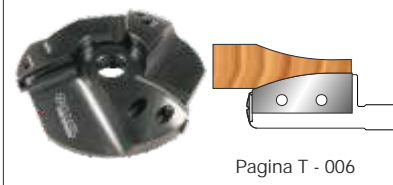

Articolo TA. 05



Articolo TA. 06



Articolo TA. 07





Foto by Arredo Bar Tonolli ( Brentonico TN )

NOTE

# FRESA PIATTABANDA MULTIPROFILO

-  - MULTIPROFIL RAISED PANEL CUTTER
-  - PLATE-BANDE MULTIPROFIL
-  - UNIVERSAL ABPLATTFRAESER 6 PROFILE
-  - FRESA PLAFONES COMBINADO

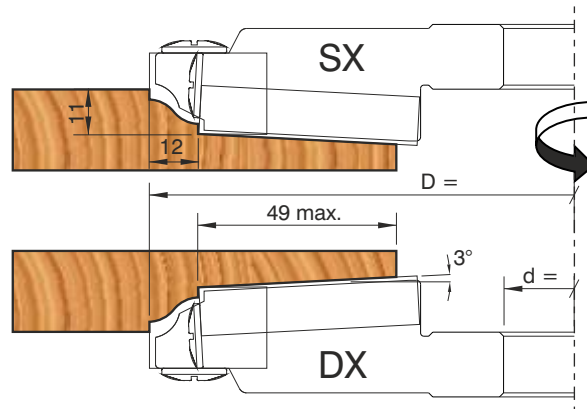
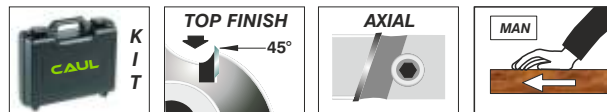

## TA.01

Ø	n.min.	n.max.
210	3600	7200



Articolo	D	B	d	Z	↶	↷	Prezzo
TA. 01.01	210	20	30/35/40/50	2+2		DX	M 1
TA. 01.02	210	20	30/35/40/50	2+2	SX		M 2

### RICAMBI-SPARE PARTS-RECHANGES-ERSATZTEILE-RECAMBIOS

Articolo	Descrizione	Dimensione	Prezzo
S0. CH.60	 Coltello / Knife	60x12x1.5	B36
CU. TB.10	 Cuneo / Wedge	50x12x10	A1
VU. DS.02	 Vite / Screw	M8x19	A45
VU. OC.02	 Ogiva / Nut	M8	A46
SC. CM.03	 Chiave / Allen Key	B 4	A27
CU. 03616PD02	 Cuneo / Wedge	20x30x10 DX	H9
CU. 03616PS02	 Cuneo / Wedge	20x30x10 SX	H9
VU. DS.03	 Vite / Screw	M8x22	A45
VU. OP.01	 Ogiva / Nut	M8	A47
SC. CM.03	 Chiave / Allen Key	B 4	A27

L'utensile è costruito da una unica testa in due versioni ( DX / SX ) sulla quale è possibile alternativamente montare 6 coltellini con differenti profili che si autoposizionano nelle apposite sedi. In fase di ordinazione va specificato il profilo desiderato indicando il relativo codice del coltellino.

The tool consists in a single cutterhead in two version ( DX / SX ) on which it is possible to mount alternatively 6 knives with different profiles, which selfpositioning themselves. When ordering, please specify desired profile indicating the relative knife code.



L'outil est formé d'une seule pièce en deux versions ( DX / SX ). Il est possible de fixer alternativement 6 lames de différents profils se positionnant automatiquement. Lors de la commande, il est nécessaire de préciser le profil désiré, en indiquant la référence des couteaux.

Das Werkzeug besteht aus einem einzelnen Messerkopf in zwei Ausführungen ( DX / SX ). Auf diese können alternativ 6 Messer mit verschiedenen Profilen, die selbstpositioniert sind, angebracht werden. Im Falle eines Auftrags bitten wir, das gewünschte Profil mit dem entsprechenden Messer-Code anzugeben.

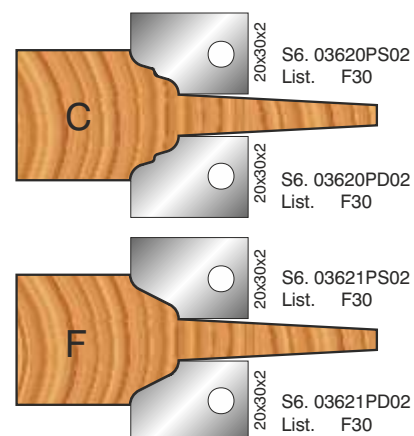
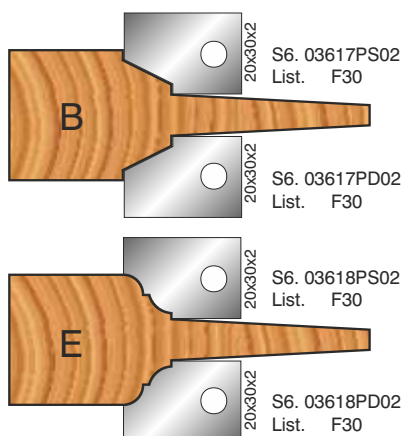
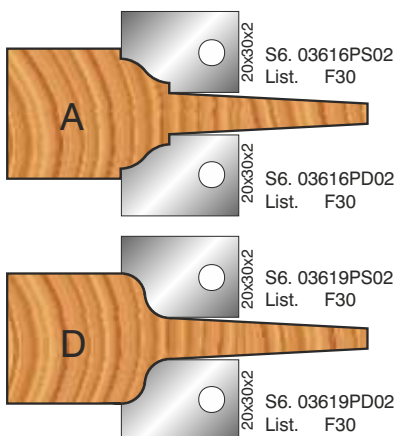
La herramienta consiste en un cabezal sencillo en dos versiones ( DX / SX ) sobre el cual es posible montar alternativamente 6 cuchillas con diferentes perfiles, los cuales se autoposicionan. Al realizar un pedido, por favor especificar perfil deseado indicando el código de cuchilla correspondiente.



# FRESA PIATTABANDA A PROFILI MULTIPLI

-  - MANY PROFILES PANEL RAISING CUTTER HEAD
-  - PORTE-OUTIL POUR PLATE-BANDES MULTIPROFILS
-  - MULTI-PROFILER ABPLATTMESSERKOPF
-  - HERRAMIENTA PARA PLATABANDAS MULTIPERFILES

TA.02

Ø	n.min.	n.max.
210	3600	7200

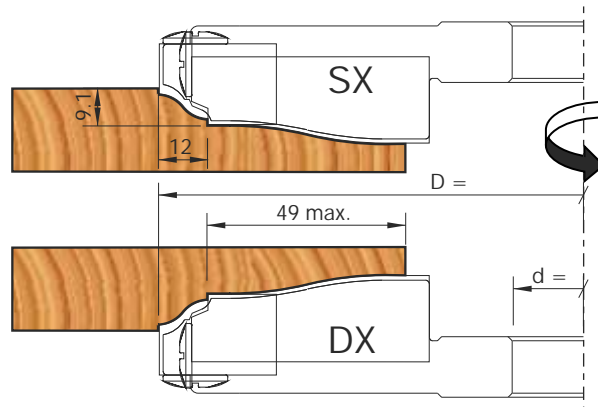
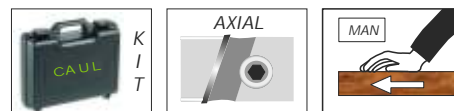

Articolo	D	B	d	Z	↺	↻	Prezzo
TA. 02.01	210	20	30/35/40/50	2+2		DX	M 3
TA. 02.02	210	20	30/35/40/50	2+2		SX	M 4

## RICAMBI-SPARE PARTS-RECHANGES-ERSATZTEILE-RECAMBIOS

Articolo	Descrizione	Dimensione	Prezzo
CU. 03630PD30	 Cuneo / Wedge	60x25x10 DX	H9
CU. 03630PS30	 Cuneo / Wedge	60x25x10 SX	H9
CU. 03616PD02	 Cuneo / Wedge	20x30x10 DX	H9
CU. 03616PS02	 Cuneo / Wedge	20x30x10 SX	H9
VU. TA.02	 Vite / Screw	M6x20	G36
SC. CT.04	 Chiave / Allen Key	T 25	A30

L'utensile è costruito da una unica testa in due versioni ( DX / SX ) sulla quale è possibile alternativamente montare 6 coltellini con differenti profili che si autopositionano nelle apposite sedi. In fase di ordinazione va specificato il profilo desiderato indicando il relativo codice del coltellino.

*The tool consists in a single cutterhead in two version ( DX / SX ) on which it is possible to mount alternatively 6 knives with different profiles, which selpositioning themselves. When ordering, please specify desired profile indicating the relative knife code.*

L'outil est formé d'une seule pièce en deux versions ( DX / SX ). Il est possible de fixer alternativement 6 lames de différents profils se positionnant automatiquement. Lors de la commande, il est nécessaire de préciser le profil désiré, en indiquant la référence des couteaux.

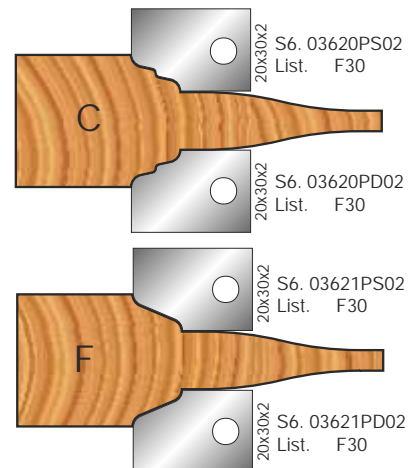
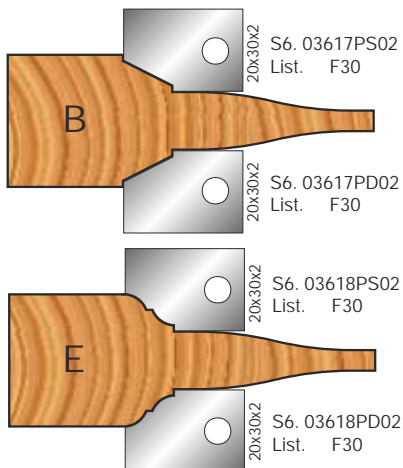
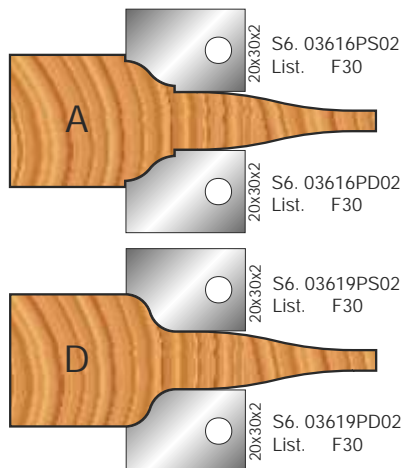
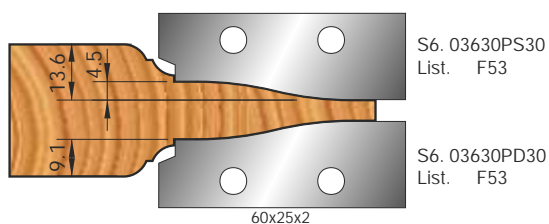

*Das Werkzeug besteht aus einem einzelnen Messerkopf in zwei Ausführungen ( DX / SX ). Auf diese können alternativ 6 Messer mit verschiedenen Profilen, die selbstpositionierend sind, angebracht werden. Im Falle eines Auftrags bitten wir, das gewünschte Profil mit dem entsprechenden Messer-Code anzugeben.*

La herramienta consiste en un cabezal sencillo en dos versiones ( DX / SX ) sobre el cual es posible montar alternativamente 6 cuchillas con diferentes perfiles, los cuales se autopositionan. Al realizar un pedido, por favor especificar perfil deseado indicando el código de cuchilla correspondiente.





# FRESA PIATTABANDA A PROFILI MULTIPLI

-  - MANY PROFILES PANEL RAISING CUTTER HEAD
-  - PORTE-OUTIL POUR PLATE-BANDES MULTIPROFILS
-  - MULTI-PROFILER ABPLATTMESSERKOPF
-  - HERRAMIENTA PARA PLATABANDAS MULTIPERFILES

## TA.03

Ø	n.min.	n.max.
200	3800	7400

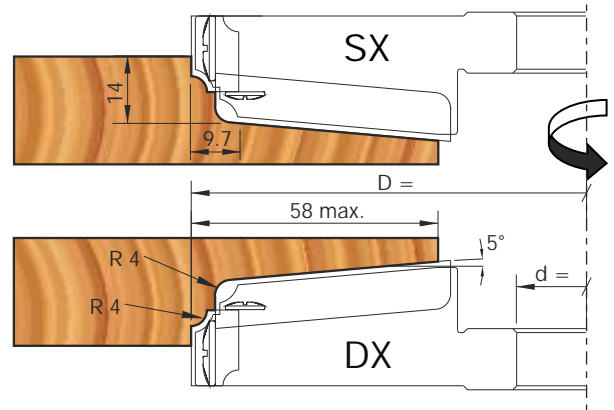
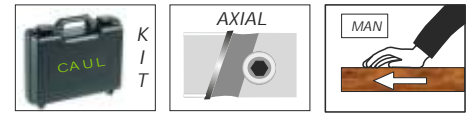

Articolo	D	B	d	Z	↶	↷	Prezzo
TA. 03.01	200	20	30/35/40/50	2+2		DX	M 5
TA. 03.02	200	20	30/35/40/50	2+2		SX	M 6

### RICAMBI-SPARE PARTS-RECHANGES-ERSATZTEILE-RECAMBIOS

Articolo	Descrizione	Dimensione	Prezzo
CU. TB.10	 Cuneo / Wedge	50x12x10	A1
VU. DS.03	 Vite / Screw	M8x22	A45
VU. OC.02	 Ogiva / Nut	M8	A46
SC. CM.03	 Chiave / Allen Key	B 4	A27
CU. 03025FD20	 Cuneo / Wedge	20x12x10 DX	H9
CU. 03025FS20	 Cuneo / Wedge	20x12x10 SX	H9

La fresa viene fornita con la serie di 5 coppie di inserti profilati intercambiabili.

*The cutter head is supplied with a set of 5 pairs of changeable moulded knives.*



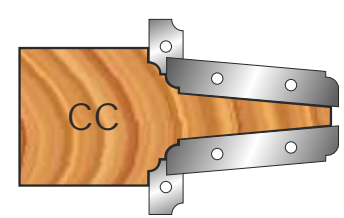
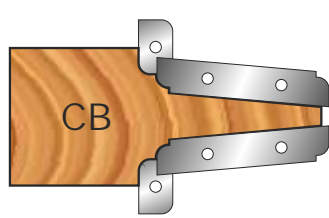
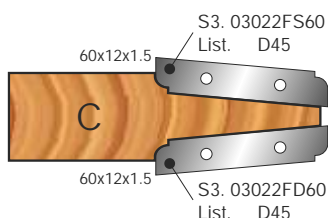
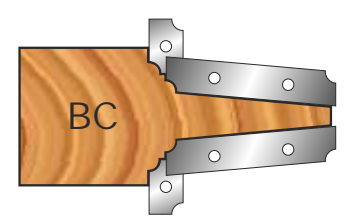
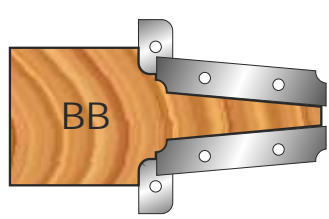
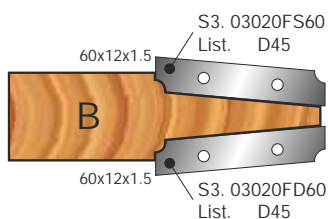
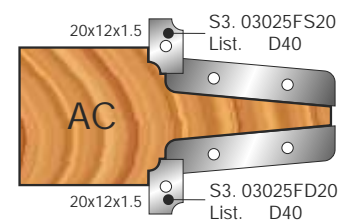
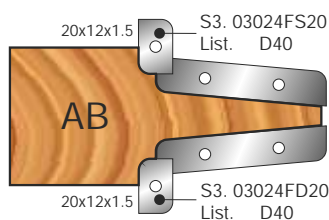
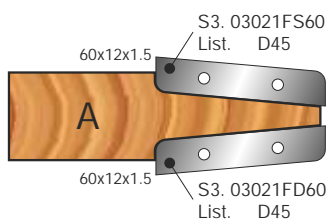

Le porte-outil est fourni de 5 paires de plaquettes profilées interchangeable.

*Der Messerkopf wird mit 5 verschiedenen Austauschbaren Profilpaaren geliefert.*

La herramienta esta abastecida con 5 paros de cuchillas perfiladas.



# FRESA PIATTABANDA

-  - RAISED PANEL CUTTER
-  - PORTE-OUTIL POUR PLATE-BANDES
-  - ABPLATTFRÄSER
-  - HERRAMIENTA PARA PLATABANDAS

## TA.04

Ø	n.min.	n.max.
210	3600	7200

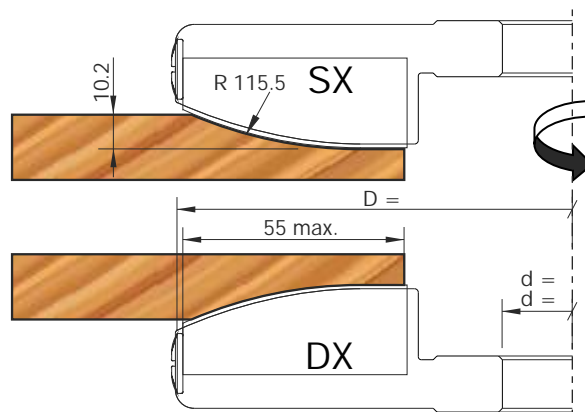
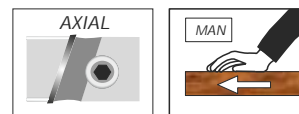

Articolo	D	B	d	Z	↶	↷	Prezzo
TA. 04.01	210	20	30/35/40/50	3		DX	M 7
TA. 04.02	210	20	30/35/40/50	3		SX	M 8

Fresa sagomata a profilo concavo, il profilo è ottenuto con un unico coltello sagomato.





*Raised panel cutter with concave profile, the profile is executed by one profiled knife.*

Fraise pour plate-bande avec profil concave, le profil est obtenu par une seule plaquette profilée.

*Abplattfräser mit konkavem Profil, das Profil wird durch ein profiliertes Messer bearbeitet.*



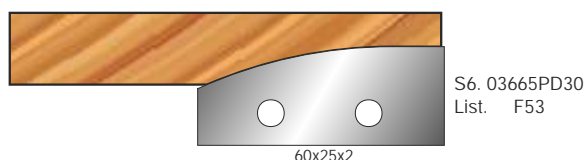
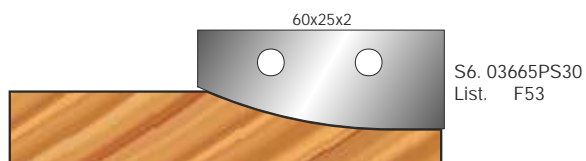

Fresa para plafones con perfil còncavo, la moldura es obtenida con una cuchilla perfilada.

### RICAMBI-SPARE PARTS-RECHANGES-ERSATZTEILE-RECAMBIOS

Articolo	Descrizione	Dimensione	Prezzo
CU. 03665PD30	 Cuneo / Wedge	60x25x10 DX	H9
CU. 03665PS30	 Cuneo / Wedge	60x25x10 SX	H9
VU. TA.02	 Vite / Screw	M6x20	G36
SC. CT.04	 Chiave / Allen Key	T 25	A30



# FRESA COMBINATA PER ANTINE

-  - COMBINED CUTTER FOR DOORS
-  - FRAISE COMBINÉE POUR PETITES PORTES
-  - KOMBI-MOEBELTUERFRAESE
-  - FRESA COMBINADA PARA PUERTAS DE COCINA

## TA.05

Ø	n.min.	n.max.
162	4700	8200

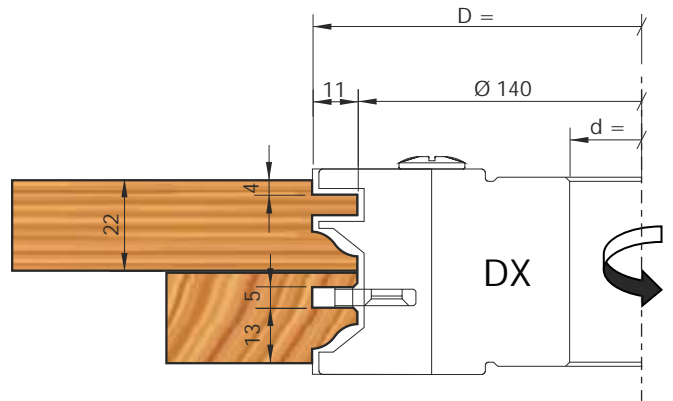
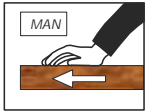

Articolo	D	B	d	Z	↶	↷	Prezzo
TA. 05.01	162	50	30/35/40/50	2		DX	M 9

### RICAMBI-SPARE PARTS-RECHANGES-ERSATZTEILE-RECAMBIOS

Articolo	Descrizione	Dimensione	Prezzo
CU. 04028PD23	 Cuneo / Wedge	50x30x10 DX	H9
VU. DS.04	 Vite / Screw	M10x22	A45
VU. OP.02	 Ogiva / Nut	M10	A47
SC. CM.04	 Chiave / Allen Key	B 5	A27
S5. SB.05	 Inserto/Insert	25x20x5	F3
VU. VS.02	 Vite / Screw	M6x15	A44
SC. CM.03	 Chiave / Allen Key	B 4	A27

In fase di ordinazione va specificato il profilo desiderato indicando il relativo codice del coltellino.

*When ordering, please specify desired profile indicating the relative knife code.*

Lors de la commande, il est nécessaire de préciser le profil désiré, en indiquant la référence des couteaux.

*Im Falle eines Auftrags bitten wir, das gewünschte Profil mit dem entsprechenden Messer-Code anzugeben.*

Al realizar un pedido, por favor especificar perfil deseado indicando el código de cuchilla correspondiente.

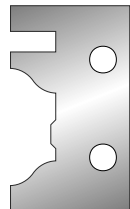

S6. 04028PD23  
List. F50

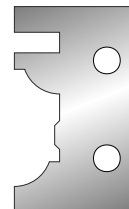
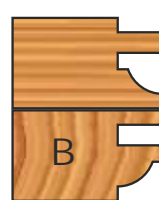

S6. 04027PD23  
List. F50





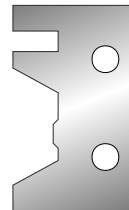
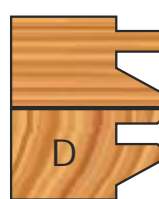

S6. 04030PD23  
List. F50



S6. 04029PD23  
List. F50

# FRESE COMBINATE PER ANTINE

-  - COMBINED CUTTERS FOR DOORS
-  - FRAISES COMBINÉES POUR PETITES PORTES
-  - KOMBI-MOEBELTUERFRAESER
-  - FRESAS COMBINADAS PARA PUERTAS DE COCINA

## TA.06

Ø	n.min.	n.max.
170	4500	8000

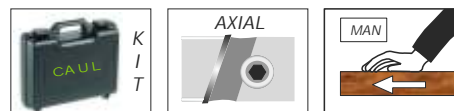

Articolo	D	B	d	Z	↶	↷	Prezzo
TA. 06.01	170	33	30/35/40/50	2		DX	M 10

### RICAMBI-SPARE PARTS-RECHANGES-ERSATZTEILE-RECAMBIOS

Articolo	Descrizione	Dimensione	Prezzo
CU. 04031PD13	 Cuneo / Wedge	35x35x10 DX	H9
VU. TA.02	 Vite / Screw	M6x20	G36
SC. CT.04	 Chiave / Allen Key	T25	A30
SO. CF.20	 Coltello / Knife	20x12x1.5	B6
CU. TB.06	 Cuneo / Wedge	20x12x10	A1
VU. DS.03	 Vite / Screw	M8x22	A45
VU. OC.02	 Ogiva / Nut	M8	A46
S4. SR.01	 Rasante / Shavers	38x16x4	E21
S5. SB.05	 Inserto / Insert	25x20x5	F3
VU. VS.02	 Vite / Screw	M6x15	A44
SC. CM.03	 Chiave / Allen Key	B 4	A27
S4. RT.01	 Rasante / Shavers	22.86x2.5	E19
VU. RB.02	 Vite / Screw	M5x8	G42
SC. CT.03	 Chiave / Allen Key	T20	A30

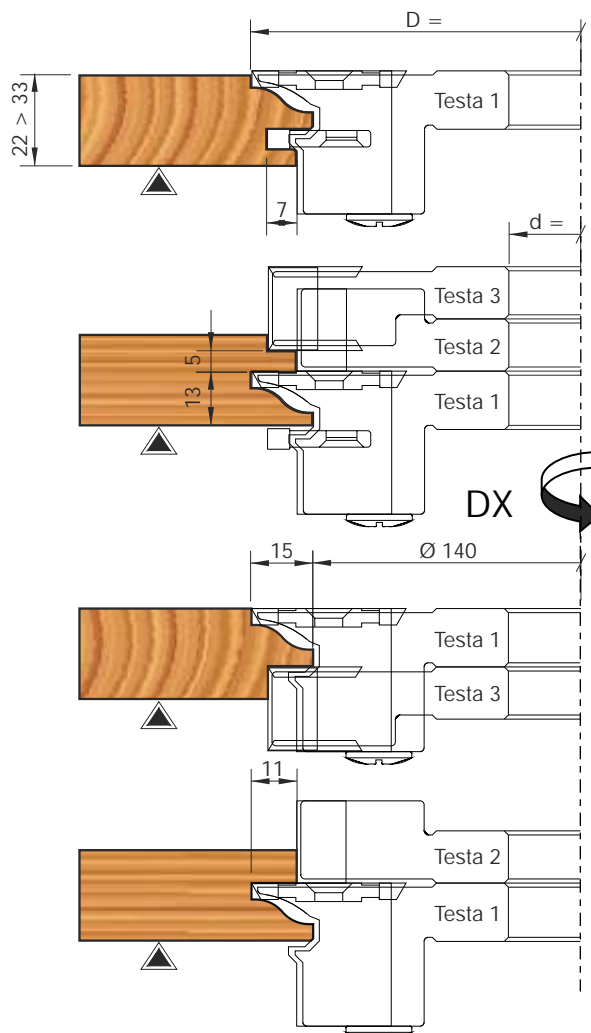

Set composto da tre teste programmate, con coltelli in HW per la produzione di antine per mobili. In fase di ordinazione va specificato il profilo desiderato indicando il relativo codice del coltellino.

*Set composed of 3 programmed tools, with HW knives for the production of furniture doors. When ordering, please specify desired profile indicating the relative knife code.*

Série composée de 3 Outils pré-élabérés, avec couteaux en HW pour fabriquer des petites portes de meubles. Lors de la commande, il est nécessaire de préciser le profil désiré, en indiquant la référence des couteaux.





*Satz bestehend aus drei programmierten Werkzeugen, mit HW zur Herstellung von Moebeltueren. Im Falle eines Auftrags bitten wir, das gewünschte Profil mit den entsprechenden Messer-Code anzugeben.*

Juego compuesto de 3 herramientas programadas con cuchillas en HW para la producción de puertas para muebles.

Al realizar un pedido, por favor especificar perfil deseado indicando el código de cuchilla correspondiente.



# FRESE COMBINATE PER ANTINE

-  - COMBINED CUTTERS FOR DOORS
-  - FRAISES COMBINÉES POUR PETITES PORTES
-  - KOMBI-MOEBELTUERFRAESER
-  - FRESAS COMBINADAS PARA PUERTAS DE COCINA

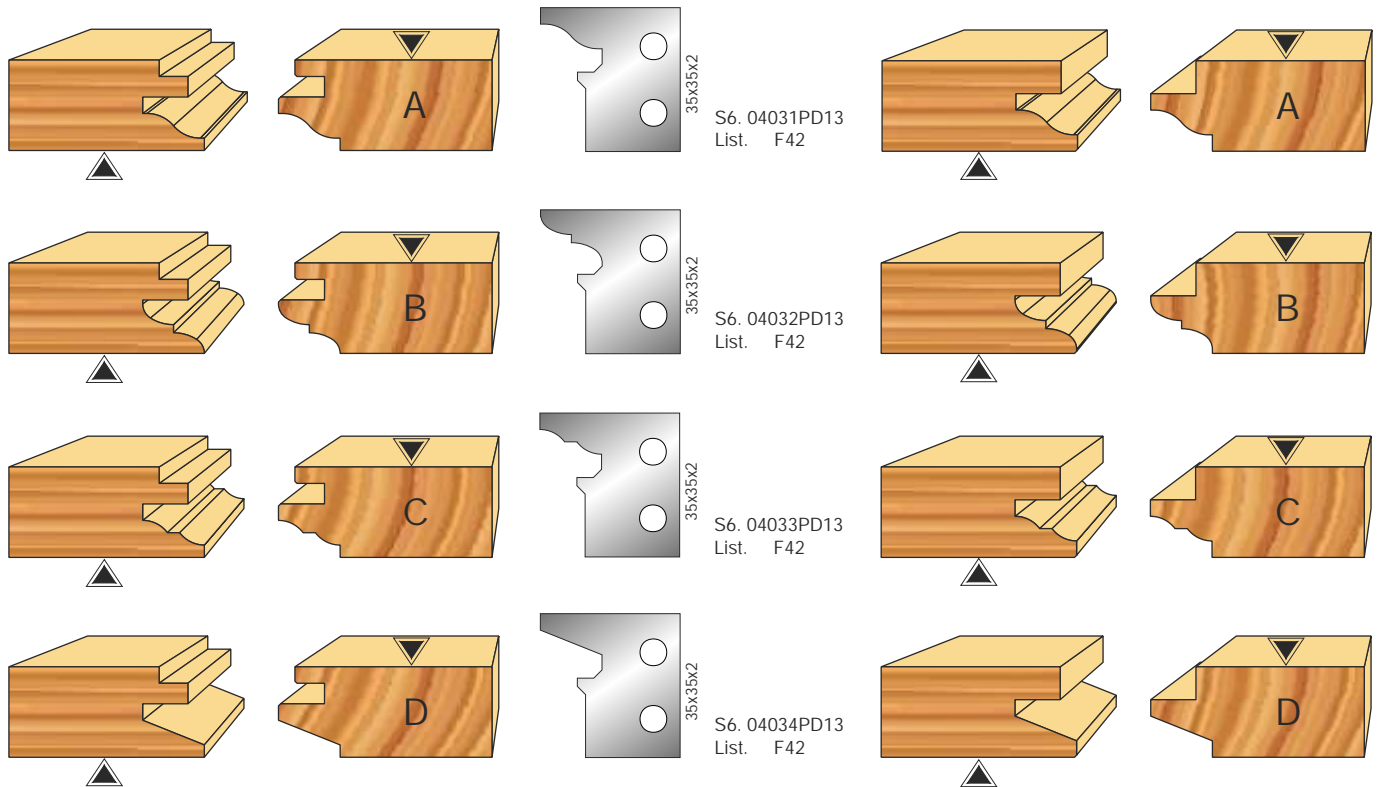



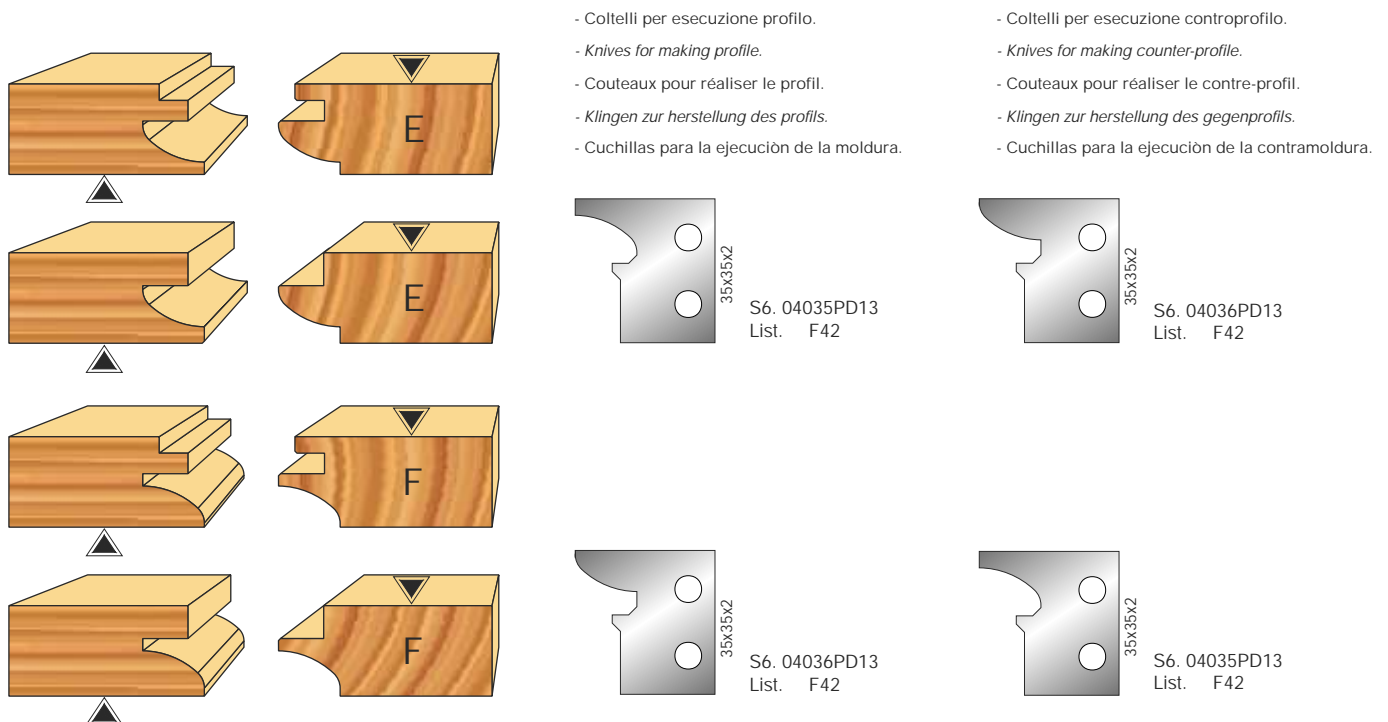

- Per eseguire il profilo E - F aggiungere al prezzo del set utensili N° 2 coltelli esecuzione controprofilo.
- For carry out the Profile E - F add to the set tools price N° 2 Knives for making counter-profile.
- Pour exécuter le profil E - F ajouter a le prix de le serie de Outils N° 2 Couteaux pour réaliser le contre-profil.
- Für die Herstellung von Profil E und F haben Sie einen Mehrpreis von Zwei Messer für dier Herstellung des Gegenprofils.
- Por llevar Perfil E - F agregar al precio del juego de las herramientas N° 2 Cuchillas para la ejecución de la contramoldura.



- Coltelli per esecuzione profilo.
- Knives for making profile.
- Couteaux pour réaliser le profil.
- Klingen zur herstellung des profils.
- Cuchillas para la ejecución de la moldura.
- Coltelli per esecuzione controprofilo.
- Knives for making counter-profile.
- Couteaux pour réaliser le contre-profil.
- Klingen zur herstellung des gegenprofils.
- Cuchillas para la ejecución de la contramoldura.

# FRESE COMBINATE PER ANTINE

-  - COMBINED CUTTERS FOR DOORS
-  - FRAISES COMBINÉES POUR PETITES PORTES
-  - KOMBI-MOEBELTUERFRAESER
-  - FRESAS COMBINADAS PARA PUERTAS DE COCINA

## TA.07

Ø	n.min.	n.max.
170	4500	8000

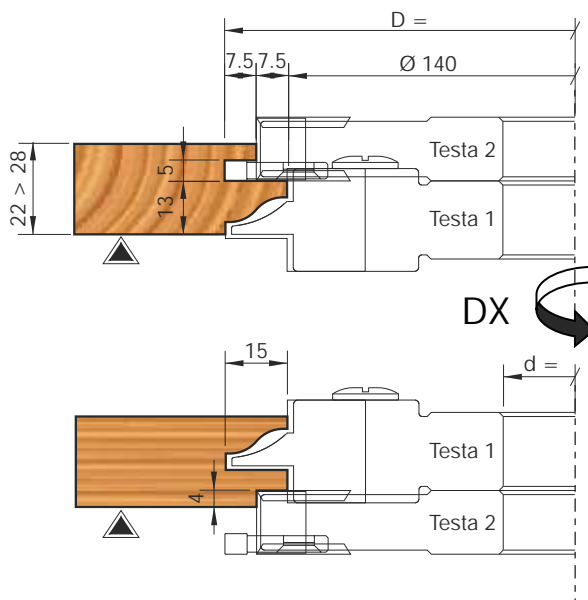
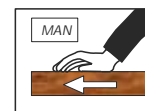

Articolo	D	B	d	Z	↶	↷	Prezzo
TA. 07.01	170	28	30/35/40/50	2		DX	M 11

### RICAMBI-SPARE PARTS-RECHANGES-ERSATZTEILE-RECAMBIOS

Articolo	Descrizione	Dimensione	Prezzo
CU. 04060PD06	 Cuneo / Wedge	25x35x10 DX	H9
VU. DS.04	 Vite / Screw	M10x22	A45
VU. OP.02	 Ogiva / Nut	M10	A47
SC. CM.04	 Chiave / Allen Key	B 5	A27
SO. CF.15	 Coltello / Knife	15x12x1.5	B5
CU. TB.05	 Cuneo / Wedge	15x12x10	A1
VU. DS.01	 Vite / Screw	M6x18	A45
VU. OC.01	 Ogiva / Nut	M6	A46
SC. CM.02	 Chiave / Allen Key	B 3	A27
S5. SB.05	 Inserto / Insert	25x20x5	F3
VU. VS.02	 Vite / Screw	M6x15	A44
SC. CM.03	 Chiave / Allen Key	B 4	A27
S4. RT.01	 Rasante / Shavers	22.86x2.5	E19
VU. RB.02	 Vite / Screw	M5x8	G42
SC. CT.03	 Chiave / Allen Key	T20	A30

Set composto da due teste programmate, con coltelli in HW per la produzione di antine per mobili. In fase di ordinazione va specificato il profilo desiderato indicando il relativo codice del coltellino.





Set composed of 2 programmed tools, with HW knives for the production of furniture doors. When ordering, please specify desired profile indicating the relative knife code.

Série composée de 2 Outils pré-élaborés, avec couteaux en HW pour fabriquer des petites portes de meubles. Lors de la commande, il est nécessaire de préciser le profil désiré, en indiquant la référence des couteaux.

Satz bestehend aus zwei programmierten Werkzeugen, mit HW zur Herstellung von Moebeltueren. Im Falle eines Auftrags bitten wir, das gewünschte Profil mit dem entsprechenden Messer-Code anzugeben.

Juego compuesto de 2 herramientas programadas con cuchillas en HW para la producción de puertas para muebles. Al realizar un pedido, por favor especificar perfil deseado indicando el código de cuchilla correspondiente.

# FRESE COMBINATE PER ANTINE

-  - COMBINED CUTTERS FOR DOORS
-  - FRAISES COMBINÉES POUR PETITES PORTES
-  - KOMBI-MOEBELTUERFRAESER
-  - FRESAS COMBINADAS PARA PUERTAS DE COCINA

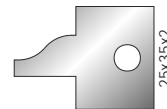
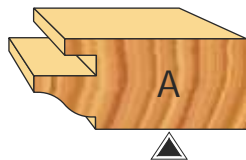
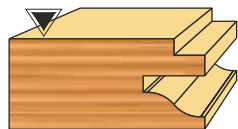

S6. 04060PD06  
List. F34

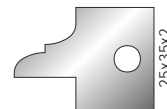
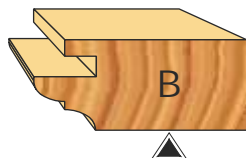
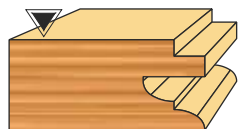

S6. 04061PD06  
List. F34

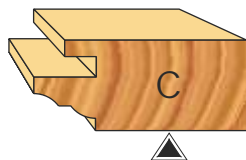
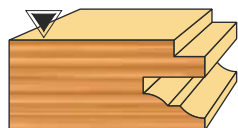

S6. 04062PD06  
List. F34

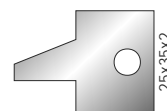
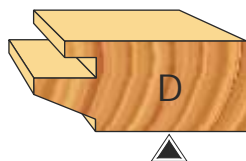
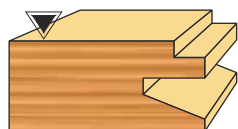

S6. 04063PD06  
List. F34

- Per eseguire il profilo E - F aggiungere al prezzo del set utensili N° 2 coltelli esecuzione controprofilo.
- For carry out the Profile E - F add to the set tools price N° 2 Knives for making counter-profile.
- Pour exécuter le profil E - F ajouter a le prix de le serie de Outils N° 2 Couteaux pour réaliser le contre-profil.
- Für Profil E - F zu verrichten der Preis von set Werkzeug hinzuFügen N° 2 Klingen zur herstellung des gegenprofils.
- Por llevar Perfil E - F agregar al precio del juego de las herramientas N° 2 Cuchillas para la ejecución de la contramoldura.

- Coltelli per esecuzione profilo.
- Knives for making profile.
- Couteaux pour réaliser le profil.
- Klingen zur herstellung des profils.
- Cuchillas para la ejecución de la moldura.

- Coltelli per esecuzione controprofilo.
- Knives for making counter-profile.
- Couteaux pour réaliser le contre-profil.
- Klingen zur herstellung des gegenprofils.
- Cuchillas para la ejecución de la contramoldura.

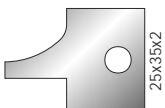
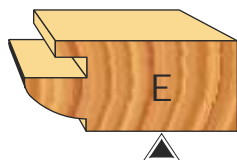
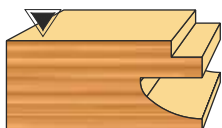

S6. 04065PD06  
List. F34

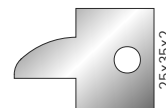

S6. 04064PD06  
List. F34

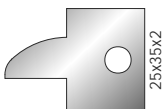
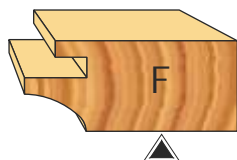
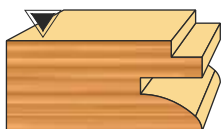



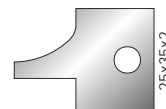

S6. 04064PD06  
List. F34



S6. 04065PD06  
List. F34

# IL LAVORO LA NOSTRA PASSIONE

-  - *WORK OUR PASSION*
-  - *TRAVAILLER NOTRE PASSION*
-  - *ARBEIT UNSERE LEIDENSCHAFT*
-  - *TRABAJAR NUESTRA PASIÓN*

