









PUNTE CNC SAGOMATE

-  - CNC ROUTER CUTTERS PROFILED
-  - CNC MÈCHES PROFIL
-  - CNC PROFILFRÄSER
-  - CNC BROCAS PARA MOLDURA

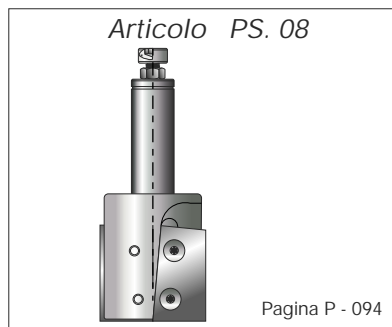
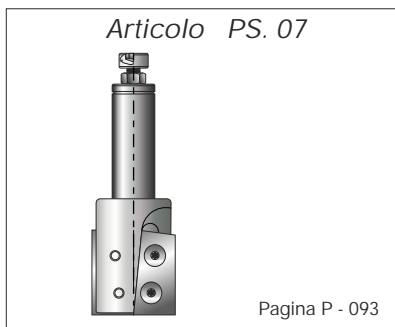
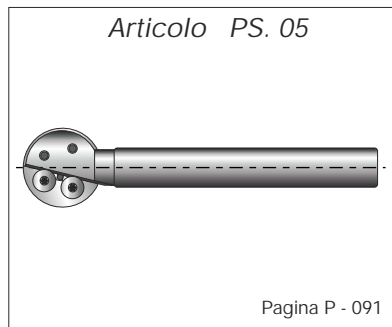
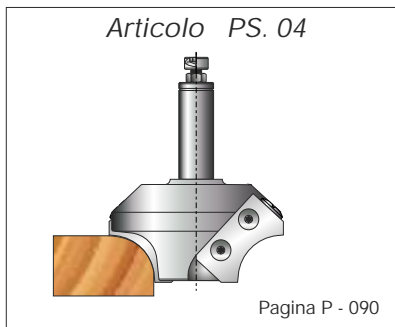
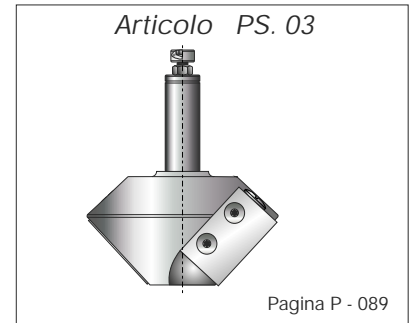
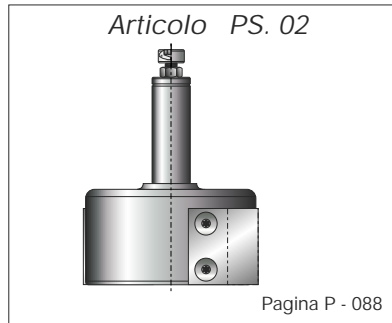
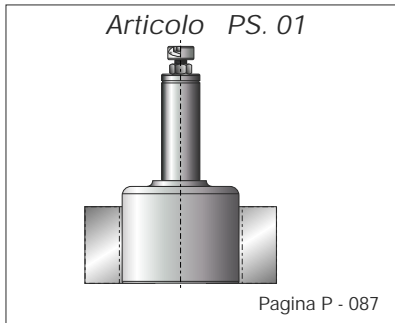
PS



PUNTA CNC PORTACOLTELLI SAGOMATI - MULTIPROFILO





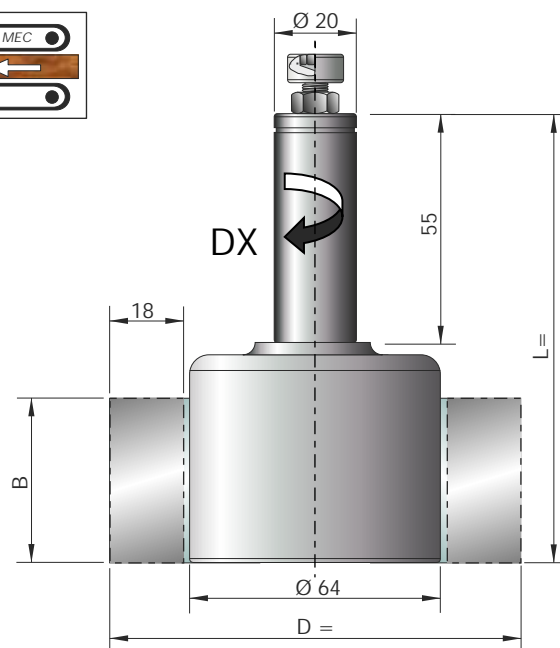
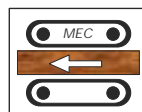

-  - CNC ROUTER CUTTERS FOR PROFILE - MULTIPROFIL
-  - CNC MÈCHES AVEC COUTEAUX PROFILÉS - MULTI-PROFILS
-  - CNC OBERFRÄSER FUER MULTIPROFILE
-  - CNC BROCAS PARA CUCHILLAS PERFILADOS - MULTI-PERFIL

PS.01

Ø	n.min.	n.max.
100		10500



Articolo	D	B	L	Attacco	Z	↶	↷	Prezzo
PS. 01.01	100	30	98	20X55/25X55	2	DX	Z 15	
PS. 01.02	100	35	103	20X55/25X55	2	DX	Z 16	
PS. 01.03	100	40	108	20X55/25X55	2	DX	Z 17	
PS. 01.04	100	50	118	20X55/25X55	2	DX	Z 18	
PS. 01.05	100	60	128	20X55/25X55	2	DX	Z 19	

RICAMBI-SPARE PARTS-RECHANGES-ERSATZTEILE-RECAMBIOS				
Articolo		Descrizione	Dimensione	Prezzo
VU. DS.03		Vite / Screw	M8x22	A45
VU. OP.01		Ogiva / Nut	M8	A47
VU. SA.01		Vite / Screw	M5x8	G48
SC. CM.03		Chiave / Allen Key	B 4	A27
VU. DS.04		Vite / Screw	M10x22	A45
VU. OP.02		Ogiva / Nut	M10	A47
SC. CM.04		Chiave / Allen Key	B 5	A27

Testa con placche in HW e placchette di supporto per l'esecuzione di profili sagomati su legno massiccio.

Cutterhead with carbide blank and back support for making shaped profiles in solid wood.

Fraise avec plaquette carbure et porte-plaquette pour l'exécution de multiprofil-de bois massifs.

Messerköpfe mit hartmetall-blankett und stützplatte zur profilieren in holz massiv.

Fresa con en pieza en bruto de metal duro y placa de soporte para realizar perfiles de formas especiales en madera maciza.

- L'utensile viene fornito privo di coltelli.
- The tool is supplied without knives.
- L'outil est fourni sans les couteaux.
- Das Werkzeug wird ohne Messern geliefert.
- La herramienta se entrega sin cuchillas.

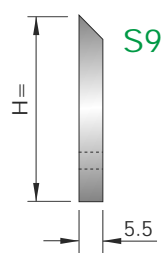



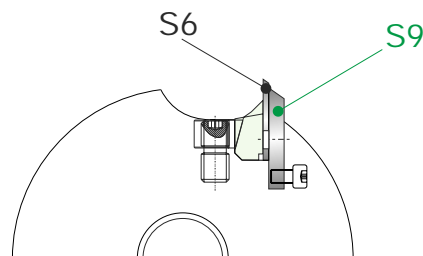

Articolo	B	H	Tipo	Codice Prezzo	Codice Prezzo
PS. 01.50	30	35	Profilato	L 19	
PS. 01.51	35	35	Profilato	L 20	
PS. 01.52	40	35	Profilato	L 21	
PS. 01.53	50	35	Profilato	L 22	
PS. 01.54	60	35	Profilato	L 23	
PS. 01.55	30	35	Grezzo		L 24
PS. 01.56	35	35	Grezzo		L 25
PS. 01.57	40	35	Grezzo		L 26
PS. 01.58	50	35	Grezzo		L 27
PS. 01.59	60	35	Grezzo		L 28



- S6** - Placchette in HW
 - Carbide Blank
 - Plaquette carbure
 - Hartmetall-Blankett
 - Pieza en bruto de metal duro

- S9** - Placchette di supporto
 - Back Support
 - Porte-plaquette
 - Stützplatte
 - Placa de soporte

PUNTA CNC PORTACOLTELLI SAGOMATI - MULTIPROFILO

-  - CNC ROUTER CUTTERS FOR PROFILE - MULTIPROFIL
-  - CNC MÈCHES AVEC COUTEAUX PROFILÉS - MULTI-PROFILS
-  - CNC OBERFRÄSER FUER MULTIPROFILE
-  - CNC BROCAS PARA CUCHILLAS PERFILADOS - MULTI-PERFIL

PS.01

- IL profilo da realizzare deve essere contenuto nell'area profilabile P dell'utensile prescelto.
- *The requested profile has to be inscribed into the moulding area P of the selected tool.*
- Le profil à exécuter doit être contenu à l'intérieur de la partie profilable P de l'outil choisi.
- *Das ausführende Profil muss in die Profilierungfläche vom gewählten P Werkzeug entgehalten sein.*
- El perfil a realizar debe estar contenido en la parte perfilable P de l'herramienta escogida.

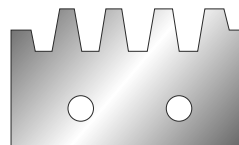
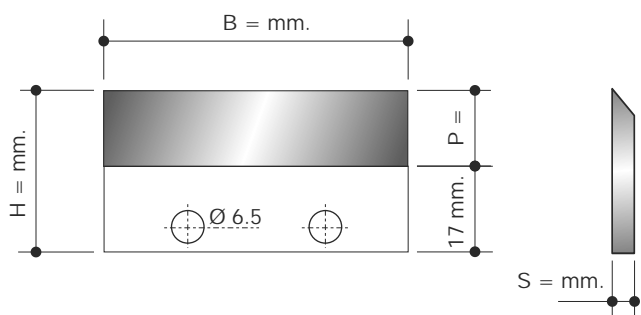

- Per profili a giunzione aumento 20 %.
- *For profiles joints add 20 %.*
- Pour profils ansemblages augmentation 20 %.
- *Fuer Verbindungs-profilis die Steigerung 20 %.*
- Para perfiles juntas aumento 20 %.

Coltelli Profilati

Articolo	B	H	P	S	Prezzo Unitario Kit. 6 Pezzi
S6. KP09	30	35	18	2	F 38
S6. KP13	35	35	18	2	F 42
S6. KP17	40	35	18	2	F 47
S6. KP24	50	35	18	2	F 51
S6. KP32	60	35	18	2	F 55





Coltelli Grezzi

Articolo	B	H	P	S	Prezzo Unitario Kit. 6 Pezzi
S6. GP09	30	35	18	2	L 34
S6. GP13	35	35	18	2	L 35
S6. GP17	40	35	18	2	L 6
S6. GP24	50	35	18	2	L 7
S6. GP32	60	35	18	2	L 8



Articolo CU	Dimensioni Cueo	Codice Prezzo
CU. 04423PD.09	30x35x12	L 29
CU. 04423PD.13	35x35x12	L 30
CU. 04423PD.17	40x35x12	L 31
CU. 04423PD.24	50x35x12	L 32
CU. 04423PD.32	60x35x12	L 33

PUNTA CNC 90° PORTACOLTELLI SAGOMATI

-  - CNC ROUTER CUTTERS 90° FOR PROFILE
-  - CNC MÈCHES 90° AVEC COUTEAUX PROFILÉS
-  - CNC OBERFRÄSER 90° ZUM PROFIL
-  - CNC BROCAS 90° PARA CUCHILLAS PERFILADOS

PS.02

Ø	n.min.	n.max.
92		10900

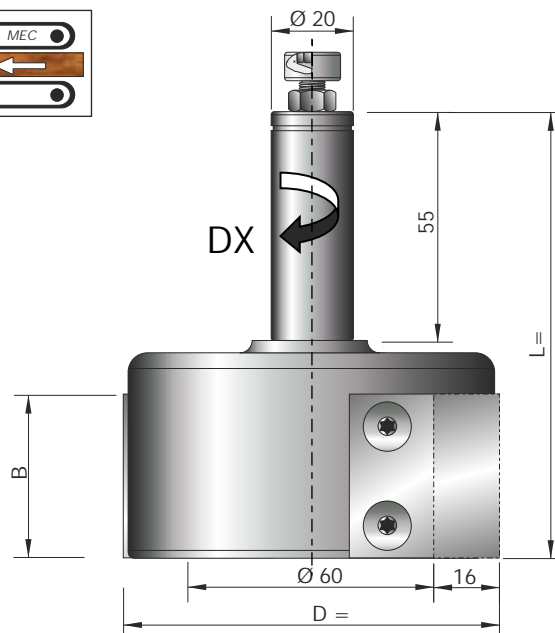
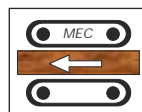

Articolo	D	B	L	Attacco	Z	↶	↷	Prezzo
PS. 02.01	92	30	98	20X55/25X55	2	DX	Z 20	
PS. 02.02	92	35	103	20X55/25X55	2	DX	Z 21	
PS. 02.03	92	40	108	20X55/25X55	2	DX	Z 22	
PS. 02.04	92	50	118	20X55/25X55	2	DX	Z 23	
PS. 02.05	92	60	128	20X55/25X55	2	DX	Z 24	

Testa con placche in HW per l'esecuzione di profili sagomati su legno massiccio. Teste corpi fresa profilati su richiesta.

Cutterhead with carbide blank for making shaped profiles in solid wood. Cutter heads made profiled on request.

Fraise avec plaquette carbure pour l'exécution de multiprofil-de bois massifs. Porte-outils profilées sur demande.

Messer köpfe mit hartmetall-blanketts zum profilieren in massivholz. Fraeser profiliert in Sonderfertigung

Fresa con en pieza en bruto de metal duro para realizar prfiles de formas especiales en madera maciza. Cabezales con cuerpo perfilados sobre demanda.

RICAMBI-SPARE PARTS-RECHANGES-ERSATZTEILE-RECAMBIOS

Articolo	Descrizione	Dimensione	Prezzo
VU. CE.01	 Vite / Screw	M5x9	G33
SC. CT.03	 Chiave / Allen Key	T20	A30

L'utensile viene fornito con 2 coltelli montati e 6 coltelli di ricambio.

The tool is supplied with 2 knives mounted and 6 knives as spare parts.

L'outil est fourni avec 2 couteaux monté et 6 couteaux de rechange.

Das Werkzeug wird mit 2 Messern geliefert und 6 ersatz Messern.

La herramienta se entrega con 2 cuchillas instalade y 6 cuchillas como recambios.

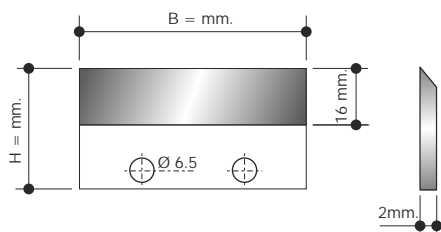

Coltelli Profilati

Articolo	B	H	P	S	Prezzo Unitario Kit. 6 Pezzi
S6. KP.09	30	35	16	2	F 38
S6. KP.13	35	35	16	2	F 42
S6. KP.17	40	35	16	2	F 47
S6. KP.24	50	35	16	2	F 51
S6. KP.32	60	35	16	2	F 55

- IL profilo da realizzare deve essere contenuto nell'area profilabile P dell'utensile prescelto.





- The requested profile has to be inscribed into the moulding area P of the selected tool.

- Le profil à exécuter doit être contenu à l'intérieur de la partie profilable P de l'outil choisi.

- Das ausführende Profil muss in die Profilierungfläche vom gewählten P Werkzeug enthalten sein.

- El perfil a realizar debe estar contenido en la parte perfilable P de l'herramienta escogida.

PUNTA CNC PER 45° PORTACOLTELLI SAGOMATI

-  - CNC ROUTER CUTTERS 45° FOR PROFILE
-  - CNC MÈCHES 45° AVEC COUTEAUX PROFILÉS
-  - CNC OBERFRÄSER 45° ZUM PROFIL
-  - CNC BROCAS 45° PARA CUCHILLAS PERFILADOS

PS.03

Ø	n.min.	n.max.
83		11500
89		11100
96		10700

Ø	n.min.	n.max.
109		10000
123		9400

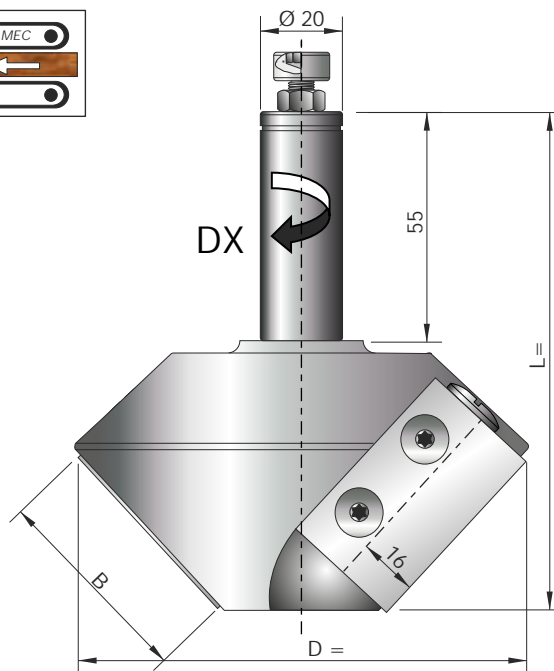
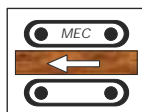

Articolo	D	B	L	Attacco	Z	↶	↷	Prezzo
PS. 03.01	83	30	111	20X55/25X55	2	DX	Z 25	
PS. 03.02	89	35	113	20X55/25X55	2	DX	Z 26	
PS. 03.03	96	40	113	20X55/25X55	2	DX	Z 27	
PS. 03.04	109	50	120	20X55/25X55	2	DX	Z 28	
PS. 03.05	123	60	128	20X55/25X55	2	DX	Z 29	

Testa con placche in HW per l'esecuzione di profili sagomati su legno massiccio. Teste corpi fresa profilati su richiesta.



Cutterhead with carbide blank for making shaped profiles in solid wood. Cutter heads made profiled on request.

Fraise avec plaquette carbure pour l'exécution de multiprofil-de bois massifs. Porte-outils profilées sur demande.

Messer köpfe mit hartmetall-blanketts zum profilieren in massivholz. Fraeser profiliert in Sonderfertigung

Fresa con en pieza en bruto de metal duro para realizar prfiles de formas especiales en madera maciza. Cabezales con cuerpo perfilados sobre demanda.

RICAMBI-SPARE PARTS-RECHANGES-ERSATZTEILE-RECAMBIOS

Articolo	Descrizione	Dimensione	Prezzo
VU. CE.01	 Vite / Screw	M5x9	G33
SC. CT.03	 Chiave / Allen Key	T20	A30

L'utensile viene fornito con 2 coltelli montati e 6 coltelli di ricambio.

The tool is supplied with 2 knives mounted and 6 knives as spare parts.

L'outil est fourni avec 2 couteaux monté et 6 couteaux de rechange.

Das Werkzeug wird mit 2 Messern geliefert und 6 ersatz Messern.

La herramienta se entrega con 2 cuchillas instalade y 6 cuchillas como recambios.

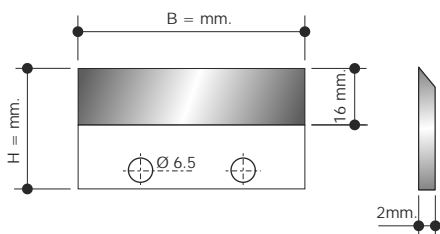





Coltelli Profilati

Articolo	B	H	P	S	Prezzo Unitario Kit. 6 Pezzi
S6. KP.09	30	35	16	2	F 38
S6. KP.13	35	35	16	2	F 42
S6. KP.17	40	35	16	2	F 47
S6. KP.24	50	35	16	2	F 51
S6. KP.32	60	35	16	2	F 55

- IL profilo da realizzare deve essere contenuto nell'area profilabile P dell'utensile prescelto.
- *The requested profile has to be inscribed into the moulding area P of the selected tool.*
- Le profil à exécuter doit être contenu à l'intérieur de la partie profilable P de l'outil choisi.
- *Das ausführende Profil muss in die Profilierungfläche vom gewählten P Werkzeug enthalten sein.*
- El perfil a realizar debe estar contenido en la parte perfilable P de l'herramienta escogida.

PUNTA CNC 1/4 TONDO CONCAVO



-  - CNC ROUTER CUTTERS FOR QUARTER ROUND CONCAVE RADIUS
-  - CNC MÈCHES POUR 1/4 DE ROND CONCAVE
-  - CNC OBERFRÄSER FUER KONKAVE VIERTELKREISE
-  - CNC BROCAS PARA RADIOS 1/4 DE TONDO CONCAVO

PS.04

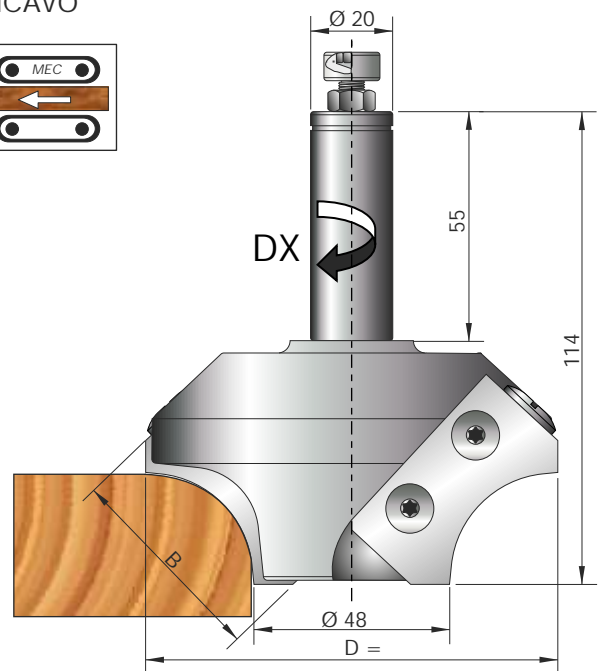
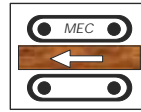
Ø	n.min.	n.max.
100		10500



Articolo	D	B	Attacco	Z	↶	↷	Prezzo
PS. 04.01	100	50	20X55/25X55	2	DX	Z 30	

RICAMBI-SPARE PARTS-RECHANGES-ERSATZTEILE-RECAMBIOS			
Articolo	Descrizione	Dimensione	Prezzo
VU. CE.01	 Vite / Screw	M5x9	G33
SC. CT.03	 Chiave / Allen Key	T20	A30

L'utensile viene fornito completo di 3 serie di coltelli:
(R15 / R20 / R25).

*The tool is supplied complete with 3 set of knives:
(R15 / R20 / R25).*



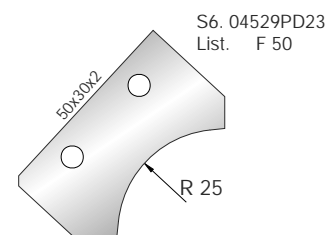
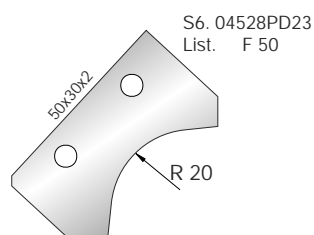
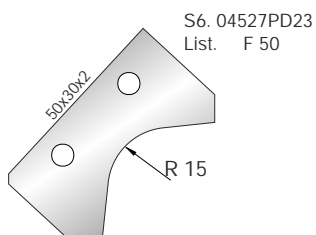

Le port-outils vient livré complete avec 3 jru de plaquettes:
(R15 / R20 / R25).

*MesserKopfsatz geliefert mit 3 Satze Abrund-Messer:
(R15 / R20 / R25).*

La herramienta se suministra con 3 serie de cuchillas:
(R15 / R20 / R25).



PUNTA CNC SAGOMATA PER COPIATURE

-  - CNC ROUTER CUTTERS FOR COPYING
-  - CNC MÈCHES PROFIL POUR COPIER
-  - CNC PROFILFRÄSER FÜR PROFIL KOPIERUNGEN
-  - CNC BROCAS PARA COPIAR

PS.05

Ø	n.min.	n.max.
40		16000

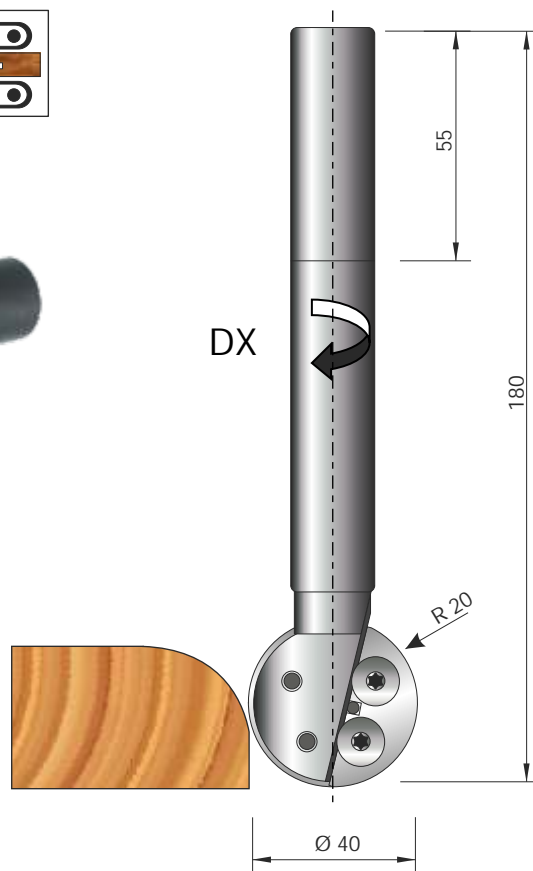
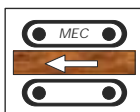

Articolo	D	B	Attacco	Z	↶	↷	Prezzo
PS. 05.01	40	40	20X55	2	DX		Z 41

L'utensile particolarmente adatto alla copiatura di profili. Esecuzione su richiesta in dimensioni personalizzate.



This tool is especially suitable to copy the profiles. We can make it with special sizes on request.

Cet outil est particulièrement adapté copier les profils. Nous pouvons le faire avec des dimensions spéciales sur demande.

Werkzeug besonders geeignet fuer die kopierung von Profilen. Auf anfrage auch in Speziellen abmessungen erhaltlich.

Esta herramienta de corte es ideal para copiar los perfiles. Podemos hacerlo con tamaños especiales bajo petición.



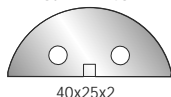

RICAMBI-SPARE PARTS-RECHANGES-ERSATZTEILE-RECAMBIOS

Articolo	Descrizione	Dimensione	Prezzo
VU. CE.01	 Vite / Screw	M5x9	G33
SC. CT.03	 Chiave / Allen Key	T20	A30

S6. 13225AD15
List. Z 45



PUNTA CNC PORTACOLTELLI SAGOMATI



-  - CNC ROUTER CUTTERS FOR PROFILE
-  - CNC MÈCHES AVEC COUTEAUX PROFILES
-  - CNC OBERFRÄSER ZUM PROFIL
-  - CNC BROCAS PARA CUCHILLAS PERFILADOS

PS.06

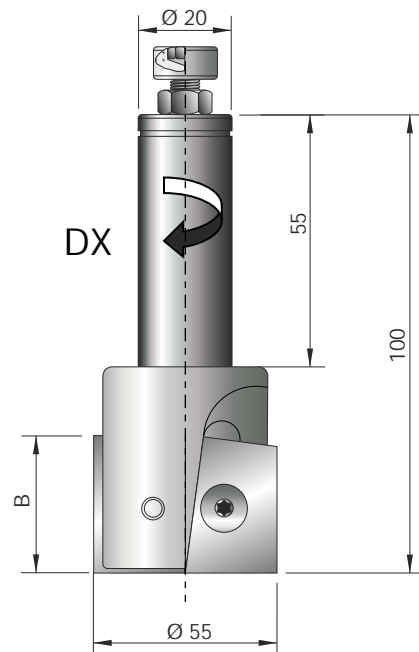
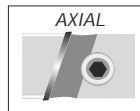
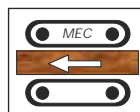
Ø	n.min.	n.max.
55		14000



Articolo	D	B	Attacco	Z	↶	↷	Prezzo
PS. 06.01	55	30	20x55/25x55	2	DX		Z 42

RICAMBI-SPARE PARTS-RECHANGES-ERSATZTEILE-RECAMBIOS				
Articolo		Descrizione	Dimensione	Prezzo
VU. CE.01		Vite / Screw	M5x9	G33
SC. CT.03		Chiave / Allen Key	T20	A30

Testa con placche in HW per l'esecuzione di profili sagomati su legno massiccio. Teste corpi fresa profilati su richiesta.

Cutterhead with carbide blank for making shaped profiles in solid wood. Cutter heads made profiled on request.

Fraise avec plaquette carbure pour l'exécution de multiprofil-de bois massifs. Porte-outils profilées sur demande.

Messer köpfe mit hartmetall-blanketts zum profilieren in massivholz. Fraeser profiliert in Sonderfertigung

Fresa con en pieza en bruto de metal duro para realizar prfiles de formas especiales en madera maciza. Cabezales con cuerpo perfilados sobre demanda.

L'utensile viene fornito con 2 coltelli montati e 6 coltelli di ricambio.

The tool is supplied with 2 knives mounted and 6 knives as spare parts.

L'outil est fourni avec 2 couteaux monté et 6 couteaux de rechange.

Das Werkzeug wird mit 2 Messern geliefert und 6 ersatz Messern.

La herramienta se entrega con 2 cuchillas instalade y 6 cuchillas como recambios.

S6. 13xxxPD07
List. F36

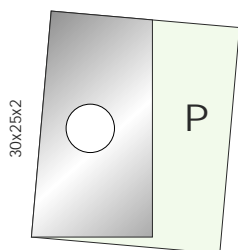

IL profilo da realizzare deve essere contenuto nell'area profilabile P dell'utensile prescelto.

The requested profile has to be inscribed into the moulding area P of the selected tool.

Le profil à exécuter doit être contenu à l'intérieur de la partie profilable P de l'outil choisi.

Das ausführende Profil muss in die Profilierungfläche vom gewählten P Werkzeug enthalten sein.

El perfil a realizar debe estar contenido en la parte perfilable P de l'herramienta escogida.



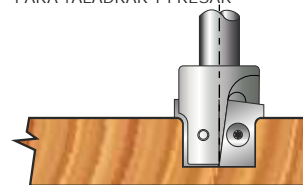
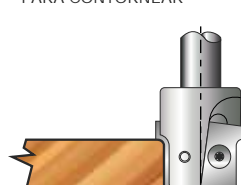
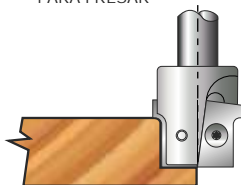

- PER FRESARE
- FOR MOLDING
- À FRAISER
- ZUM FRÄSEN
- PARA FRESAR

- PER CONTORNARE
- FOR JOINTING
- À CALIBRER
- ZUM FRÄSEN
- PARA CONTORNEAR

- PER FORARE E FRESARE
- FOR DOWEL AND MOLDING
- À PERÇER ET FRAISER
- ZUM BOHRER UND FRÄSEN
- PARA TALADRAR Y FRESAR



PUNTA CNC PORTACOLTELLI SAGOMATI

-  - CNC ROUTER CUTTERS FOR PROFILE
-  - CNC MÈCHES AVEC COUTEAUX PROFILES
-  - CNC OBERFRÄSER ZUM PROFIL
-  - CNC BROCAS PARA CUCHILLAS PERFILADOS

PS.07

Ø	n.min.	n.max.
64		14000

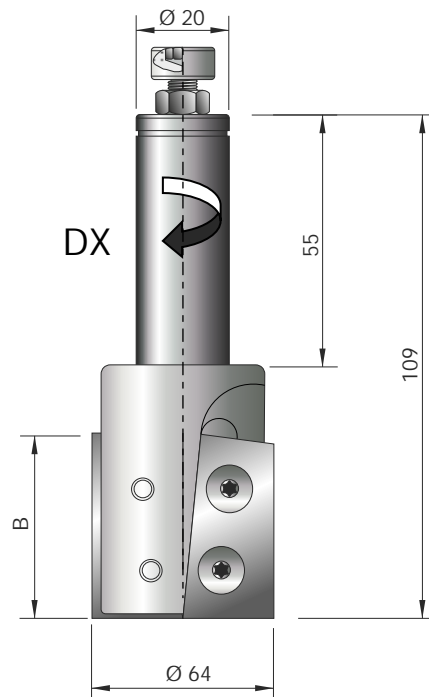
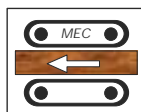

Articolo	D	B	Attacco	Z	↺	↻	Prezzo
PS. 07.01	64	40	20x55/25x55	2	DX	Z 43	

Testa con placche in HW per l'esecuzione di profili sagomati su legno massiccio. Teste corpi fresa profilati su richiesta.



Cutterhead with carbide blank for making shaped profiles in solid wood. Cutter heads made profiled on request.

Fraise avec plaquette carbure pour l'exécution de multiprofil-de bois massifs. Porte-outils profilées sur demande.

Messer köpfe mit hartmetall-blanketts zum profilieren in massivholz. Fraeser profiliert in Sonderfertigung

Fresa con en pieza en bruto de metal duro para realizar perfiles de formas especiales en madera maciza. Cabezales con cuerpo perfilados sobre demanda.

RICAMBI-SPARE PARTS-RECHANGES-ERSATZTEILE-RECAMBIOS

Articolo	Descrizione	Dimensione	Prezzo
VU. CE.01	 Vite / Screw	M5x9	G33
SC. CT.03	 Chiave / Allen Key	T20	A30

L'utensile viene fornito con 2 coltelli montati e 6 coltelli di ricambio.

The tool is supplied with 2 knives mounted and 6 knives as spare parts.

L'outil est fourni avec 2 couteaux monté et 6 couteaux de rechange.

Das Werkzeug wird mit 2 Messern geliefert und 6 ersatz Messern.

La herramienta se entrega con 2 cuchillas instalade y 6 cuchillas como recambios.

S6. 13xxxPD16
List. F46

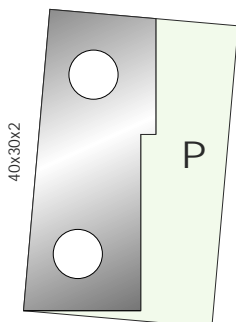

IL profilo da realizzare deve essere contenuto nell'area profilabile P dell'utensile prescelto.

The requested profile has to be inscribed into the moulding area P of the selected tool.

Le profil à exécuter doit être contenu à l'intérieur de la partie profilable P de l'outil choisi.

Das ausführende Profil muss in die Profilierungfläche vom gewählten P Werkzeug enthalten sein.

El perfil a realizar debe estar contenido en la parte perfilable P de l'herramienta escogida.



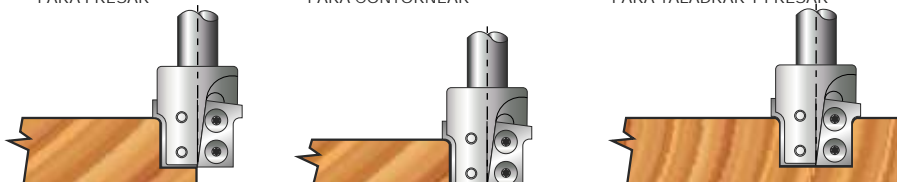

- PER FRESARE
- FOR MOLDING
- À FRAISER
- ZUM FRÄSEN
- PARA FRESAR

- PER CONTORNARE
- FOR JOINTING
- À CALIBRER
- ZUM FRÄSEN
- PARA CONTORNEAR

- PER FORARE E FRESARE
- FOR DOWEL AND MOLDING
- À PERÇER ET FRAISER
- ZUM BOHRER UND FRÄSEN
- PARA TALADRAR Y FRESAR



PUNTA CNC PORTACOLTELLI SAGOMATI



-  - CNC ROUTER CUTTERS FOR PROFILE
-  - CNC MÈCHES AVEC COUTEAUX PROFILES
-  - CNC OBERFRÄSER ZUM PROFIL
-  - CNC BROCAS PARA CUCHILLAS PERFILADOS

PS.08

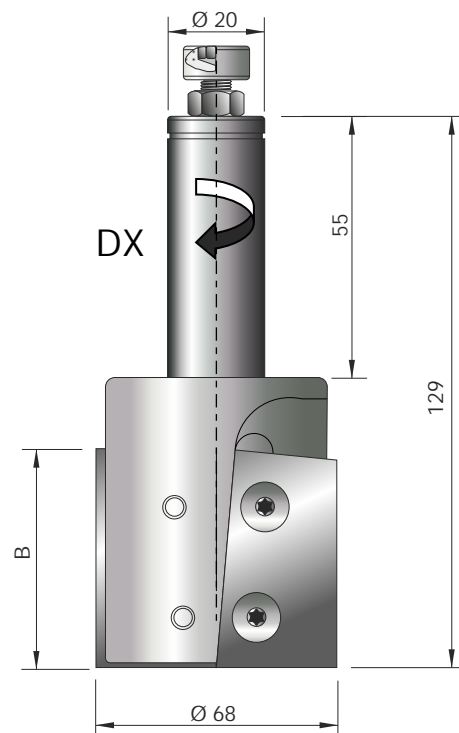
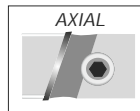
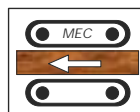
Ø	n.min.	n.max.
68		12000



Articolo	D	B	Attacco	Z	↶	↷	Prezzo
PS. 08.01	68	60	20x55/25x55	2	DX		Z 44

RICAMBI-SPARE PARTS-RECHANGES-ERSATZTEILE-RECAMBIOS				
Articolo		Descrizione	Dimensione	Prezzo
VU. CE.01		Vite / Screw	M5x9	G33
SC. CT.03		Chiave / Allen Key	T20	A30

Testa con placche in HW per l'esecuzione di profili sagomati su legno massiccio. Teste corpi fresa profilati su richiesta.

Cutterhead with carbide blank for making shaped profiles in solid wood. Cutter heads made profiled on request.

Fraise avec plaquette carbure pour l'exécution de multiprofil-de bois massifs. Porte-outils profilées sur demande.

Messer köpfe mit hartmetall-blanketts zum profilieren in massivholz. Fraeser profiliert in Sonderfertigung

Fresa con en pieza en bruto de metal duro para realizar prfiles de formas especiales en madera maciza. Cabezales con cuerpo perfilados sobre demanda.

S6. 13xxxPD31
List. F54

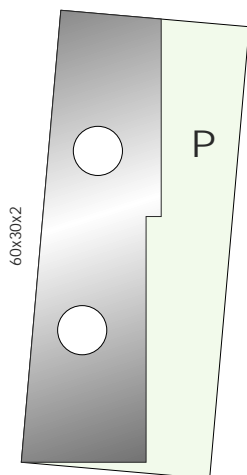

L'utensile viene fornito con 2 coltelli montati e 6 coltelli di ricambio.

The tool is supplied with 2 knives mounted and 6 knives as spare parts.

L'outil est fourni avec 2 couteaux monté et 6 couteaux de rechange.

Das Werkzeug wird mit 2 Messern geliefert und 6 ersatz Messern.

La herramienta se entrega con 2 cuchillas instalade y 6 cuchillas como recambios.

IL profilo da realizzare deve essere contenuto nell'area profilabile P dell'utensile prescelto.

The requested profile has to be inscribed into the moulding area P of the selected tool.

Le profil à exécuter doit être contenu à l'intérieur de la partie profilable P de l'outil choisi.

Das ausführende Profil muss in die Profilierungfläche vom gewählten P Werkzeug enthalten sein.

El perfil a realizar debe estar contenido en la parte perfilable P de l'herramienta escogida.



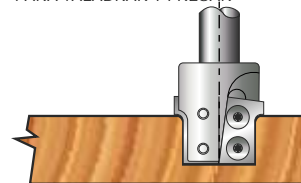
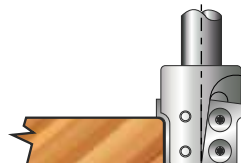
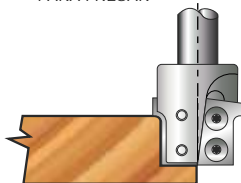

- PER FRESARE
- FOR MOLDING
- À FRAISER
- ZUM FRÄSEN
- PARA FRESAR

- PER CONTORNARE
- FOR JOINTING
- À CALIBRER
- ZUM FRÄSEN
- PARA CONTORNEAR

- PER FORARE E FRESARE
- FOR DOWEL AND MOLDING
- À PERÇER ET FRAISER
- ZUM BOHRER UND FRÄSEN
- PARA TALADRAR Y FRESAR



IL LAVORO LA NOSTRA PASSIONE

-  - *WORK OUR PASSION*
-  - *TRAVAILLER NOTRE PASSION*
-  - *ARBEIT UNSERE LEIDENSCHAFT*
-  - *TRABAJAR NUESTRA PASIÓN*

