

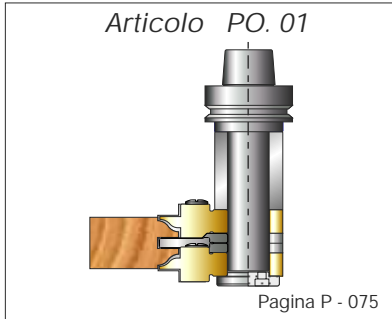



PUNTE CNC PER PORTE PROFILO E CONTROPROFILO

-  - CNC ROUTER CUTTERS FOR PROFILES AND COUNTER-PROFILES FOR DOORS
-  - CNC MÉCHES POUR MOULURES ET CONTRE-MOULURES POUR PORTES
-  - CNC DÜBEL BOEHRER FUER PROFILE UND GEGENPROFILE FUER TUEREN
-  - CNC BROCAS PARA MOLDURA-CONTROMOLDURA PARA PUERTAS

PO



PUNTA CNC PER PORTE

-  - CNC ROUTER CUTTER FOR INSIDE DOORS
-  - CNC MÈCHES POUR PORTES
-  - CNC OBERFRÄSER FÜR INNENTÜREN
-  - CNC BROCAS PARA PUERTAS

PO.01

Ø	n.min.	n.max.
130		9200

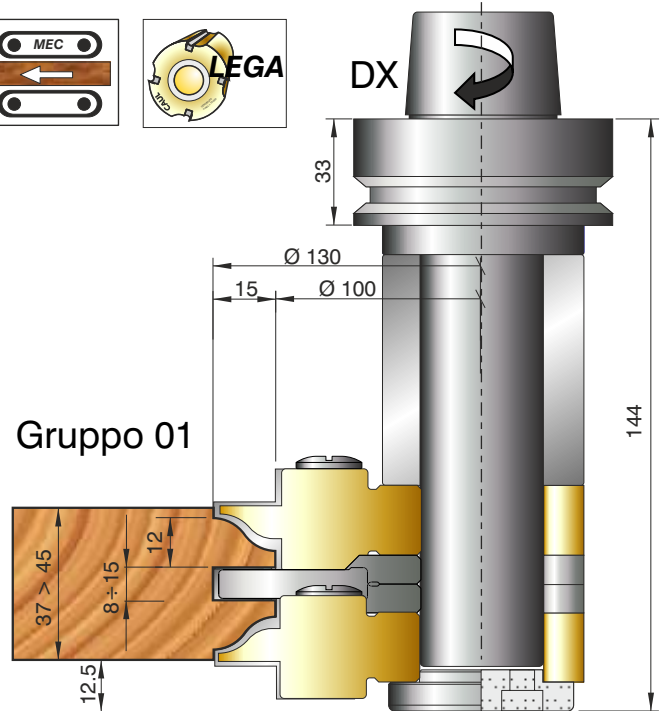
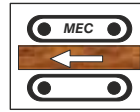

Articolo	D	B	Attacco	Riferimento	Z	↶	↷	Prezzo
PO. 01.01	130	45	HSK 63F	Gruppo 01	2	DX	Z 4	
PO. 01.02	130	45	ISO 30	Gruppo 01	2	DX	Z 5	
PO. 01.03	130	45	HSK 63F	Gruppo 02	2	DX	Z 6	
PO. 01.04	130	45	ISO 30	Gruppo 02	2	DX	Z 7	

RICAMBI-SPARE PARTS-RECHANGES-ERSATZTEILE-RECAMBIOS

Articolo	Descrizione	Dimensione	Prezzo
CU. 04417PD06	 Cuneo / Wedge	25x35x10 DX H9	
CU. 04417PS06	 Cuneo / Wedge	25x35x10 SX H9	
VU. DS.04	 Vite / Screw	M10x22 A45	
VU. OP.02	 Ogiva / Nut	M10 A47	
SC. CM.04	 Chiave / Allen Key	B 5 A27	
S4. RA.01	 Rasante / Shavers	14x14x2 E14	
VU. RB.01	 Vite / Screw	M5x6 G42	
SC. CT.03	 Chiave / Allen Key	T20 A30	
SO. CF.08	 Coltello / Knife	7.65x12x1.5 B1	
CU. TB.01	 Cuneo / Wedge	8x12x10 A1	
VU. VQ.01	 Vite / Screw	M5x25 A55	
SC. CQ.01	 Chiave / Allen Key	5x5 A35	

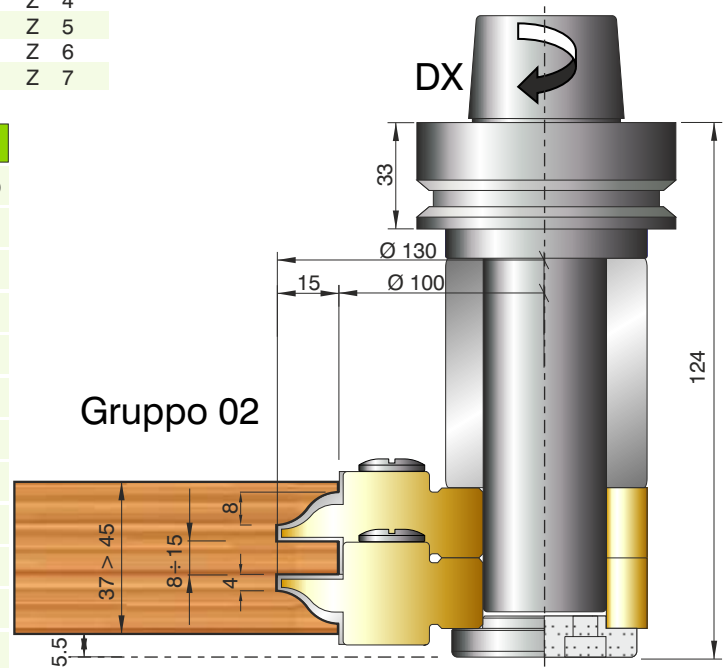

In fase di ordinazione va specificato il profilo desiderato indicando il relativo codice del coltellino.

When ordering, please specify desired profile indicating the relative Knife code.



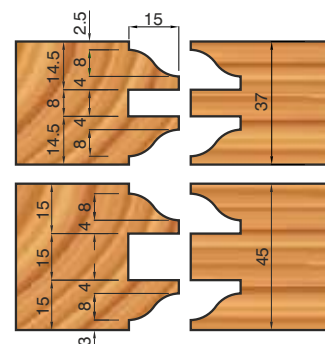

Lors de la commande, il est nécessaire de préciser le profil désiré, en indiquant la référence des couteaux.

Im Falle eines Auftrags bitten wir, das gewünschte Profil mit dem entsprechenden Messer-Code anzugeben.

Al realizar un pedido, por favor especificar perfil deseado indicando el código de cuchilla correspondiente.



PUNTA CNC PER PORTE

-  - CNC ROUTER CUTTER FOR INSIDE DOORS
-  - CNC MÈCHES POUR PORTES
-  - CNC OBERFRÄSER FÜR INNENTÜREN
-  - CNC BROCAS PARA PUERTAS

PO.01

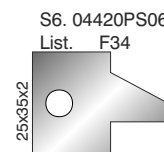
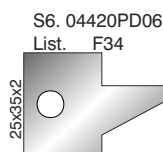
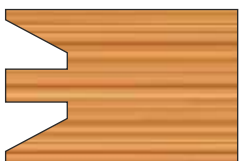
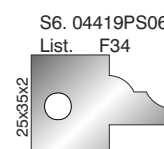
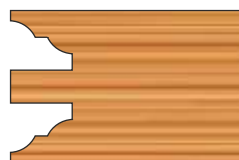
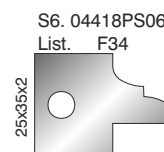
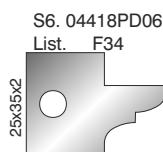
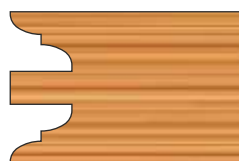
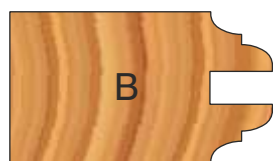
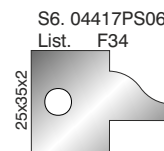
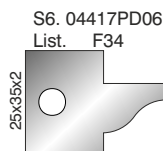
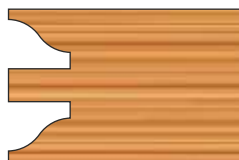
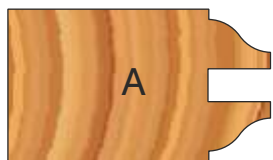

Per eseguire il profilo E - F aggiungere al prezzo del set utensili N° 2+2 coltelli esecuzione controprofilo.

For carry out the Profile E - F add to the set tools price N° 2+2 Knives for making counter-profile.

Pour exécuter le profil E - F ajouter a le prix de le serie de Outils N° 2+2 Couteaux pour réaliser le contre-profil.

Für Profil E - F Preiszuschlag extra zum Werkzeug preis fuer N° 2+2 Klingen zur herstellung des gegenprofils.

Por llevar Perfil E - F agregar al precio del juego de las herramientas N° 2+2 Cuchillas para la ejecución de la contramoldura.

- Coltelli per esecuzione controprofilo.
- Knives for making counter-profile.
- Couteaux pour réaliser le contre-profil.
- Klingen zur herstellung des gegenprofils.
- Cuchillas para la ejecución de la contramoldura.

