









PUNTE CNC PER SMUSSI

-  - CNC ROUTER BEVELLING CUTTERS
-  - CNC MÈCHES POUR CHANFREIN
-  - CNC FASEFRÄSER
-  - CNC BROCAS PARA BISELAR

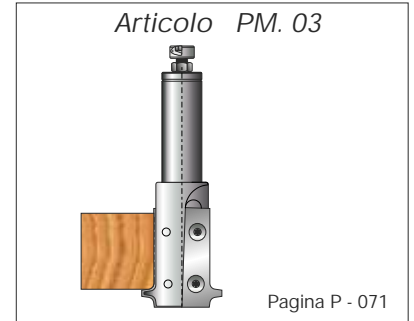
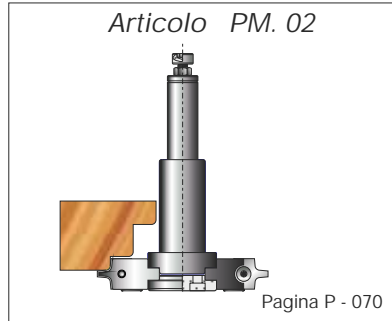
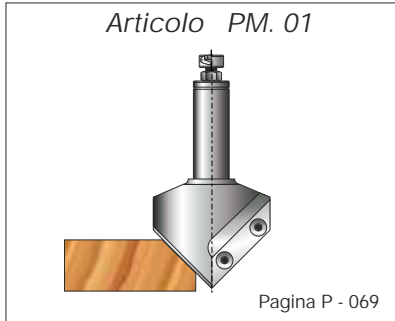
PM



PUNTA CNC PER SMUSSI

-  - CNC ROUTER BEVELLING CUTTERS
-  - CNC MÈCHES POUR CHANFREIN
-  - CNC FASEFRÄSER
-  - CNC BROCAS PARA BISELAR

PM.01

Ø	n.min.	n.max.
65		14000

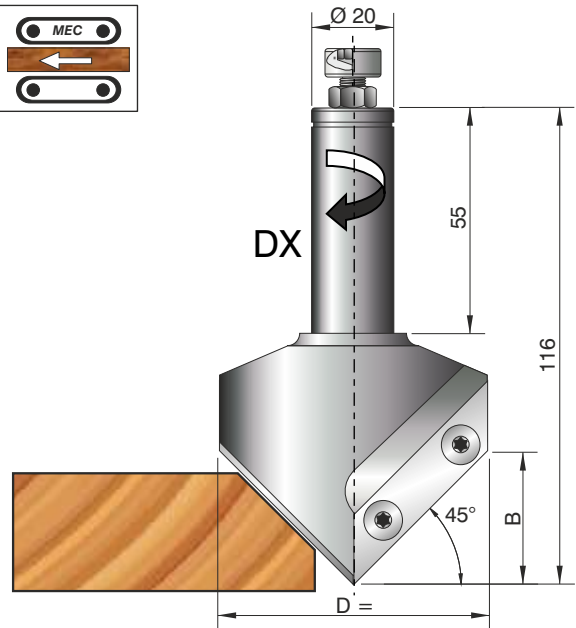
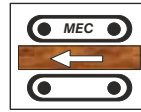

Articolo	D	B	Attacco	Z	↶	↷	Prezzo
PM. 01.01	65	32.5	20x55/25x55	2	DX		Z 1

RICAMBI-SPARE PARTS-RECHANGES-ERSATZTEILE-RECAMBIOS

Articolo	Descrizione	Dimensione	Prezzo
VU. CA.01	 Vite / Screw	M3.5x4.9	G29
SC. CT.02	 Chiave / Allen Key	T15	A30

Fresa con coltelli reversibili standard.

Cutters with standard reversible knives.

Fraise à plaquettes reversibles standard.

Fraeser mit standard wendeschneidplatten.

Fresa con cuchillas reversibles standard.

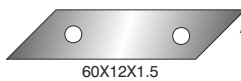

Art. S1. 03032HD60
(DX) List. L18

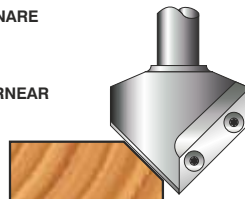

- PER CONTORNARE
- FOR JOINTING
- À CALIBRER
- ZUM FRÄSEN
- PARA CONTORNEAR

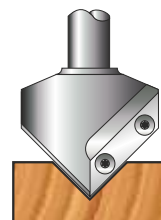

- PER FRESARE
- FOR MOLDING
- À FRAISER
- ZUM FRÄSEN
- PARA FRESAR



PUNTA CNC CON LEVASPIGOLI A 45° OPPURE RAGGIATI



-  - CNC ROUTER CUTTER WITH CORNER REMOVERS AT 45° OR RADIUS
-  - CNC MÈCHES AVEC SUPPRIMEANGLES À 45° OU RADIES
-  - CNC OBERFRÄSER MIT ENTKANTERN 45° ODER RADIAL
-  - CNC BROCAS CON ACHAFLANADORES A 45° O CON RADIO

PM.02

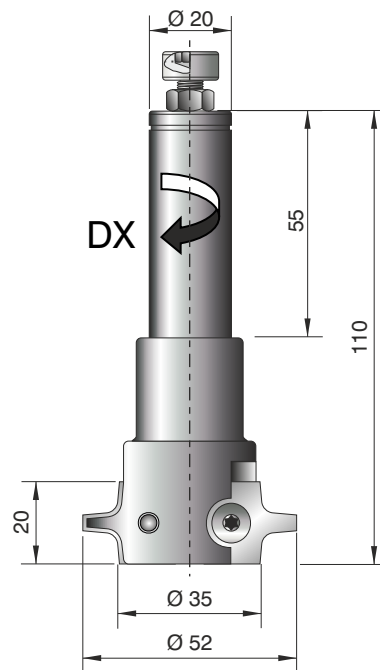
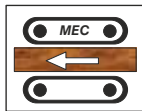
Ø	n.min.	n.max.
52		15000
112		9900



Articolo	D	B	Attacco	Z	↶	↷	Prezzo
PM. 02.01	52	20	20x55	2	DX		Z 2
PM. 02.02	112	20	20x55	2	DX		Z 3

RICAMBI-SPARE PARTS-RECHANGES-ERSATZTEILE-RECAMBIOS			
Articolo	Descrizione	Dimensione	Prezzo
VU. CE.01	 Vite / Screw	M5x9	G33
SC. CT.03	 Chiave / Allen Key	T20	A30

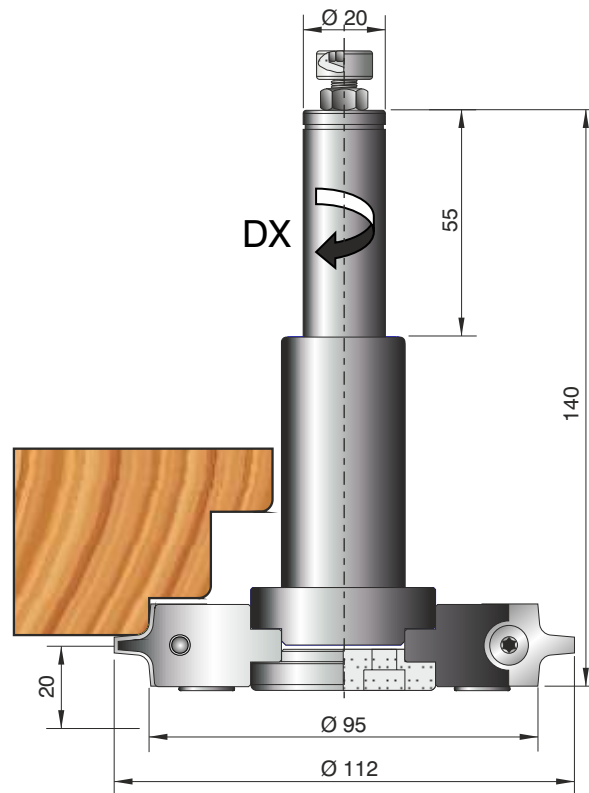

I raggi disponibili sono : R=2 / R=3 / R=4 / R=5 / R=6 / R=7 / R=8 / 45° .L'utensile viene fornito completo di una serie di coltelli per il raggio richiesto.

The available radiuses are: R=2 / R=3 / R=4 / R=5 / R=6 / R=7 / R=8 / 45° .The tool is supplied complete with a set of knives for cutting the radius required.



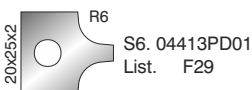
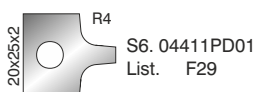

Les rayons disponibles sont: R=2 / R=3 / R=4 / R=5 / R=6 / R=7 / R=8 / 45° .Le port-outils vient livré complete avec en jru de plaquettes pour le rayon demandé.

Die erhältlichen Radien sind: R=2 / R=3 / R=4 / R=5 / R=6 / R=7 / R=8 / 45° .Das Werkzeug wird mit den Messern der gewuschten Radien geliefert.

Los radios disponibles son: R=2 / R=3 / R=4 / R=5 / R=6 / R=7 / R=8 / 45° . La herramienta se suministra con una serie de cuchillas para el radio desedeado.



PUNTA Z2 FORA E CONTORNA PER PANTOGRAFO

-  - DRILLS Z2 TO PERFORATE AND BLANK FOR PANTOGRAPH
-  - MECHES Z2 A PERCER ET CONTOURNER POUR PANTOGRAPH
-  - BOHR-EINSATZ Z2 BOHR UND KONTUREN FÜR OBERFRÄSER
-  - BROCA Z2 PARA TALADRAR Y CONTORNEAR PARA FRESADORA

PM.03

Ø	n.min.	n.max.
40		16000

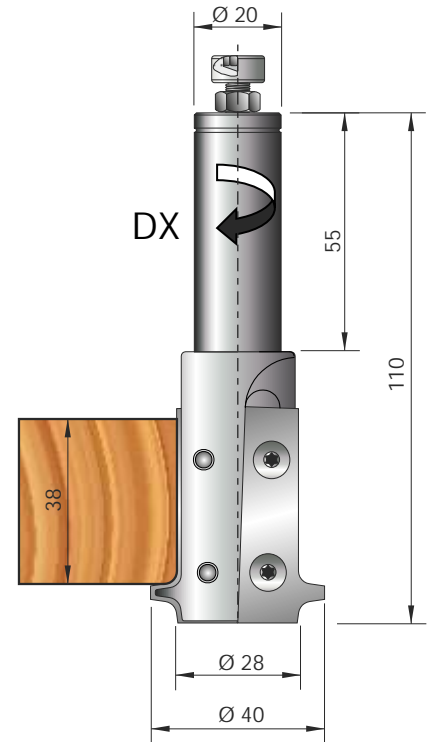
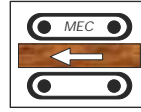

Articolo	D	B	Attacco	Z	↶	↷	Prezzo
PM. 03.01	40	38	20x55	2	DX		T 43



L'utensile viene fornito con 2 coltelli montati (A) e 2 coltelli di ricambio (B) per il raggio convesso.

The tool is supplied with 2 knives mounted and 4 knives as spare parts for radius and wood thickness required.

L'outil est fourni avec 2 couteaux montés et 4 couteaux de rechange pour le rayon et épaisseur bois demandé.

Das Werkzeug wird mit 2 montierte Messer ausgestattet und 2 Messer fuer den konvexen Radius.

La herramienta se entrega con 2 cuchillas instaladas y 4 cuchillas como recambios para el radio y el espesor de madera deseados.

RICAMBI-SPARE PARTS-RECHANGES-ERSATZTEILE-RECAMBIOS			
Articolo	Descrizione	Dimensione	Prezzo
VU. CE.01	 Vite / Screw	M5x9	G33
SC. CT.03	 Chiave / Allen Key	T20	A30

S6. 12555AS46
List. Z 40

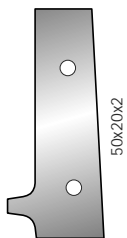

A

S6. 13434AS46
List. Z 40

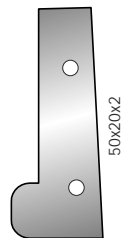



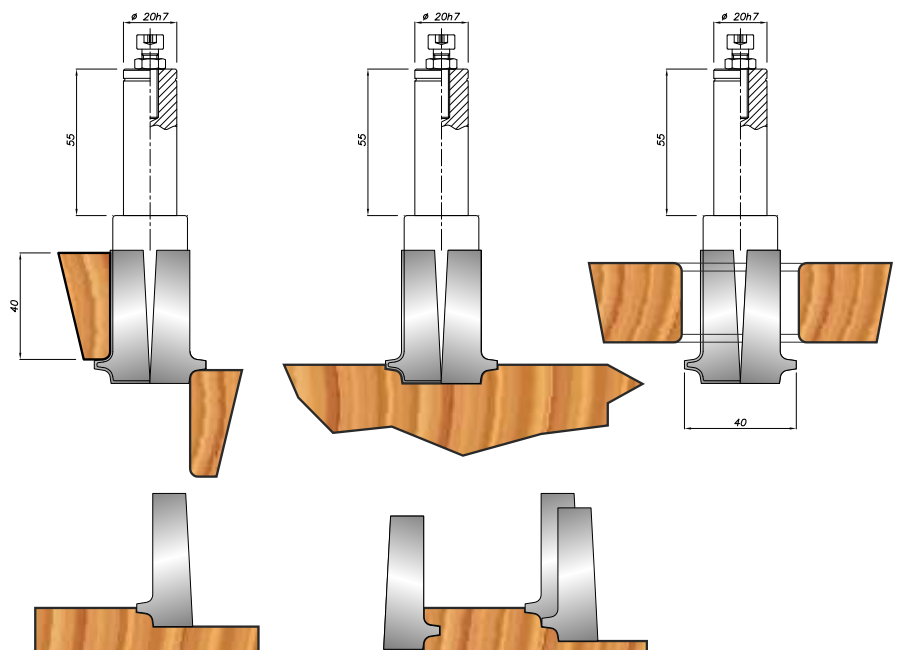

B



- Esempi di lavorazione.
- Examples of processing.
- Exemples d'usages.
- Anwendungs-beispiele.
- Ejemplo de trabajos.

IL LAVORO LA NOSTRA PASSIONE

-  - *WORK OUR PASSION*
-  - *TRAVAILLER NOTRE PASSION*
-  - *ARBEIT UNSERE LEIDENSCHAFT*
-  - *TRABAJAR NUESTRA PASIÓN*

