









PUNTE CNC PER FORARE

-  - CNC ROUTER CUTTERS FOR DOWEL
-  - CNC MÈCHES POUR PERCER
-  - CNC DÜBELBOHRER
-  - CNC BROCAS PARA TALADRAR

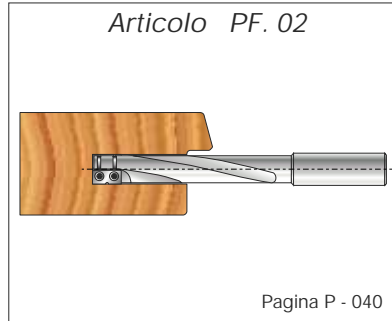
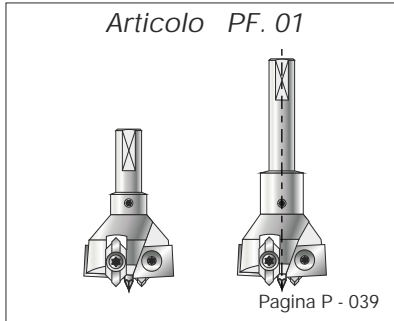
PF



PUNTE CNC PER FORARE

-  - CNC ROUTER CUTTERS FOR DOWEL
-  - CNC MÈCHES POUR PERCER
-  - CNC DÜBELBOHRER
-  - CNC BROCAS PARA TALADRAR

PF.01

Ø	n.min.	n.max.
25-26		18000
30-34-35		17000
40		16000

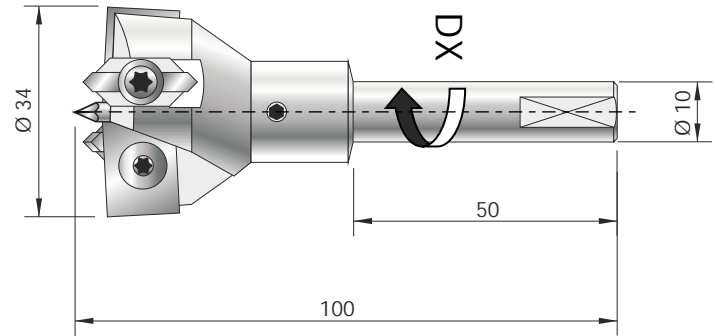
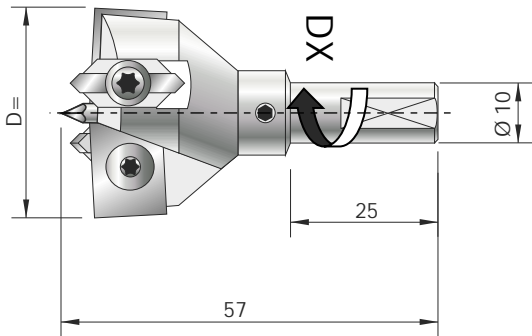
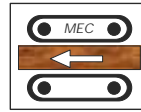

Articolo	D	B	Attacco	Z	↶	↷	Prezzo
PF. 01.01	25	57	10x25	2	DX		U 39
PF. 01.02	26	57	10x25	2	DX		U 40
PF. 01.03	30	57	10x25	2	DX		U 41
PF. 01.04	34	57	10x25	2	DX		U 42
PF. 01.05	35	57	10x25	2	DX		U 43
PF. 01.06	40	57	10x25	2	DX		U 44
PF. 01.07	34	100	10x50	2	DX		U 45

Punte CNC con coltelli reversibili standard.
 CNC router cutters with standard reversible knives.
 CNC méches à plaquettes reversibles standard.
 CNC Dübelbohrer standard wendeschneidplatten.
 CNC brocas con cuchillas reversibles standard.



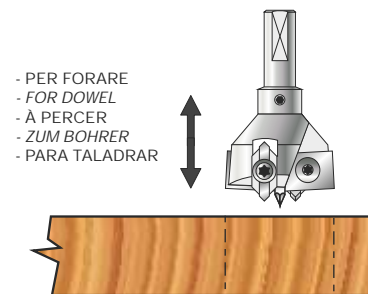

RICAMBI-SPARE PARTS-RECHANGES-ERSATZTEILE-RECAMBIOS

Articolo	Descrizione	Dimensione	Prezzo
S4. RP.02	 Rasante / Shavers	Ø 3x50	L15
S4. RP.01	 Rasante / Shavers	18x8	L14
VU. CB.02	 Vite / Screw	M4x5.9	G30
VU. CF.01	 Vite / Screw	M4x8	G34
SC. CT.02	 Chiave / Allen Key	T15	A30



Articolo	Diametro Punta	Codice Prezzo
S1. 04028FD15	25	C 26
S1. 04029FD15	26	C 26
S1. 04030FD15	30	C 26
S1. 04031FD20	34	C 27
S1. 04032FD20	35	C 27
S1. 04033FD20	40	C 27

PUNTA CNC PER CAVA SERRATURE

-  - CNC ROUTER CUTTERS FOR LOCKS
-  - CNC MÈCHES POUR SERRURES
-  - CNC DÜBELBOHRER FÜR SCHLOSS
-  - CNC BROCAS PARA HERRAJES

PF.02

Ø	n.min.	n.max.
16		18000

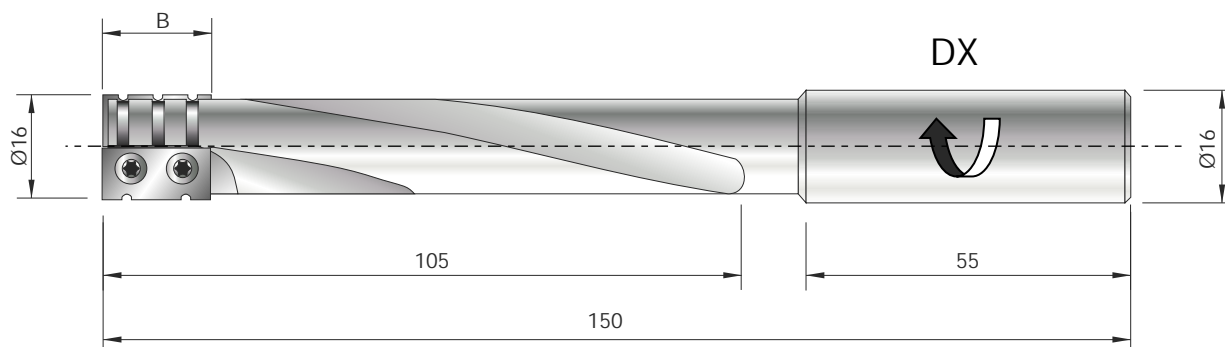
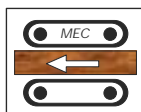

Articolo	D	B	Attacco	Z	↶	↷	Prezzo
PF. 02.01	14	150	14x50	2	DX		U 46
PF. 02.02	16	150	16x50	2	DX		U 47

Diametro costante e assenza di vibrazioni con il corpo in metallo pesante.



Constant diameter and without vibrations with heavy metal body.

Diamètre constant et sans vibrations avec el corps en metal pesant.

Beständiger Durchmesser und ohne Vibrationen mit Körper in schwer Metall.

Diametro costante y sin vibración con el cuerpo en metal pesado.

RICAMBI-SPARE PARTS-RECHANGES-ERSATZTEILE-RECAMBIOS

Articolo	Descrizione	Dimensione	Prezzo
VU. CG.01	 Vite / Screw	M3x4	G39
SC. CB.01	 Chiave / Allen Key	T 08	A23

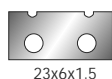

Art. S3. 04018FD30
(DX Ø 14) Lis. L16

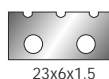

Art. S3. 04019FD30
(Dx Ø 14) List. L17

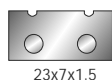

Art. S3. 04004FD30
(DX Ø 16) List. L16

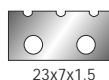

Art. S3. 04005FD30
(Dx Ø 16) List L17

- PER FORARE E FRESARE
- FOR DOWEL AND MOLDING
- À PERCER ET FRAISER
- ZUM BOHRER UND FRASEN
- PARA TALADRAR Y FRESAR

