

PUNTE CNC PER TELAI E SQUADRATURA DI PORTE

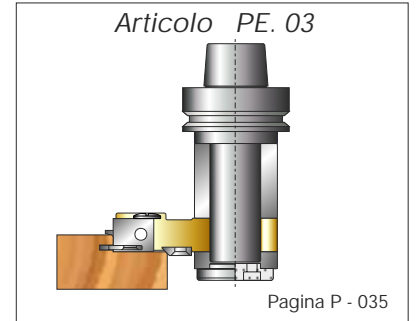

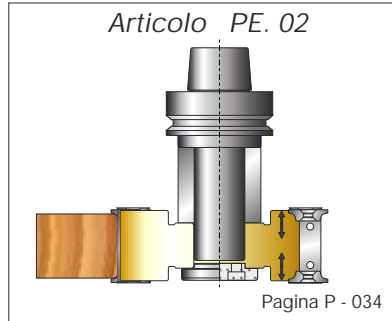

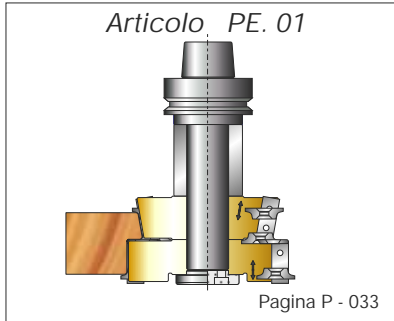

- CNC ROUTER CUTTERS FOR SQUARING DOOR FRAME
- CNC MÈCHES POUR CHÂSSIS POUR ÉQUARISSAGE DE PORTES
- CNC TUERRAHMENFRAESER UND TUEBESCHLAGUNG
- CNC BROCAS PARA MARCOS Y LA ESCUADRERÍA DE PUERTAS

PE



PUNTA CNC PER SQUADRATURA DI PORTE

-  - CNC ROUTER CUTTER FOR SQUARING DOORS
-  - CNC MÈCHES POUR ÉQUARISSAGE DES PORTES
-  - CNC FRAESERGRUPPEN FUER TUERBESCHLAGUNG
-  - CNC BROCAS PARA LA ESCUADERIA DE LAS PUERTAS





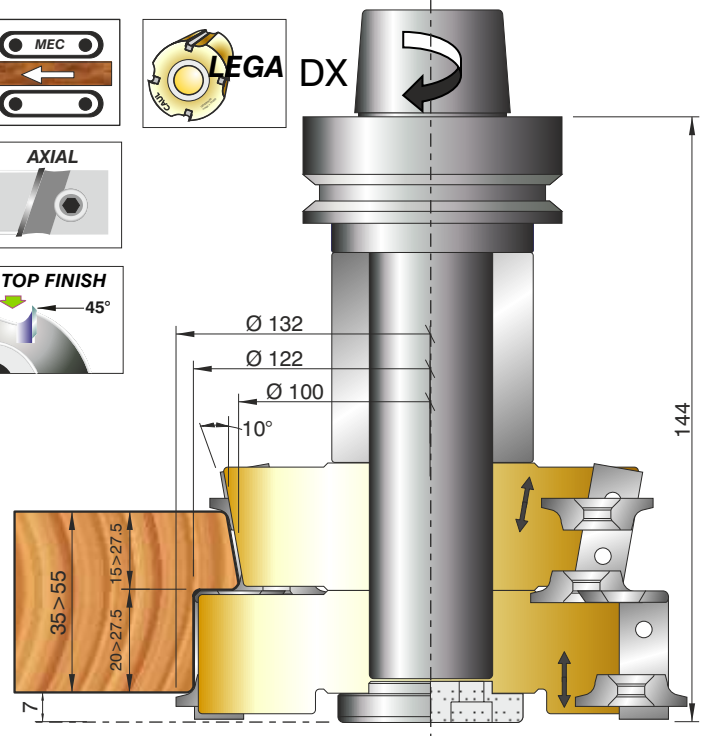
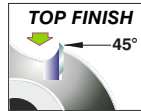
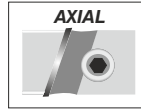
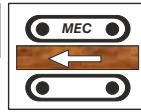











PE.01

Ø	n.min.	n.max.
115		9800



Articolo	D	B	Attacco	Z	↺	↻	Prezzo
PE. 01.01	115	55	HSK 63F	2	DX	U 33	
PE. 01.02	115	55	ISO 30	2	DX	U 34	

RICAMBI-SPARE PARTS-RECHANGES-ERSATZTEILE-RECAMBIOS

Articolo	Descrizione	Dimensione	Prezzo
S0. CH.30	 Coltello / Knife	30x12x1.5	B33
CU. TI.08	 Cuneo / Wedge	30x15x10	A3
CU. TI.07	 Cuneo / Wedge	30x15x10	A3
VU. DS.02	 Vite / Screw	M8x19	A45
VU. OC.02	 Ogiva / Nut	M8	A46
SC. CM.03	 Chiave / Allen Key	B4	A27
S4. RT.02	 Rasante / Shavers	21.9x2.5	E20
VU. RB.02	 Vite / Screw	M5x8	G42
SC. CT.03	 Chiave / Allen Key	T20	A30
S7. SB.04	 Spigolatori / Chanfering	26.8x15.8 R1.5	F22
S7. SB.05	 Spigolatori / Chanfering	26.8x15.8 R3	F23
S7. SB.06	 Spigolatori / Chanfering	26.8x15.8 R3	F23
VU. VS.02	 Vite / Screw	M6x15	A44
S7. PM.01	 Supporti / Supports	Tipo A	A4
VU. GC.06	 Vite / Screw	M6x16	A37
SC. CM.02	 Chiave / Allen Key	B 3	A27

Gruppo per squadratura porte montato su HSK 63F - ISO 30.

Tool set for doors squaring on HSK 63F - ISO 30.

Jeu de fraises pour le calibrage des portes montées sur HSK 63F ISO 30.

Fräsergarnitur für Türenaubenprofil auf HSK 63F - ISO 30.

Juego de fresas para la esquadria de puertas montadas sobre HSK 63F - ISO 30.

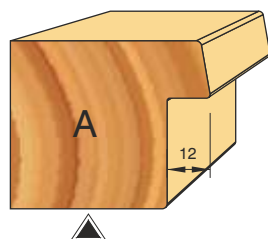
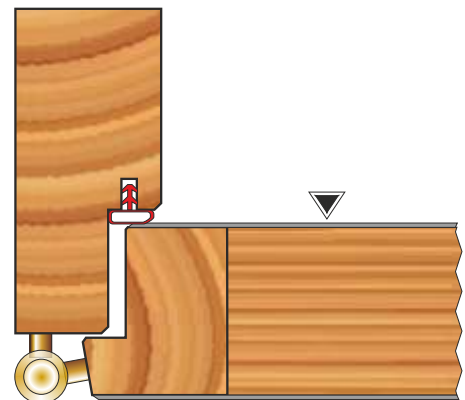

PUNTA CNC PER BATTUTE CON SPIGOLATORI REGISTRABILI

-  - CNC ROUTER CUTTERS FOR REBATING WITH ADJUSTABLE CORNER MAKING DEVICE
-  - CNC MÈCHES POUR FEUILLURER AVEC DISPOSITIF RÉGLABLE ARÊTES
-  - CNC OBERFRÄSER FÜR FALZMESSERKOPF MIT REGULIERBAREN KANTENVORRICHTUNGEN
-  - CNC BROCAS PARA GALCES CON ESPIGADORES REGULABLES





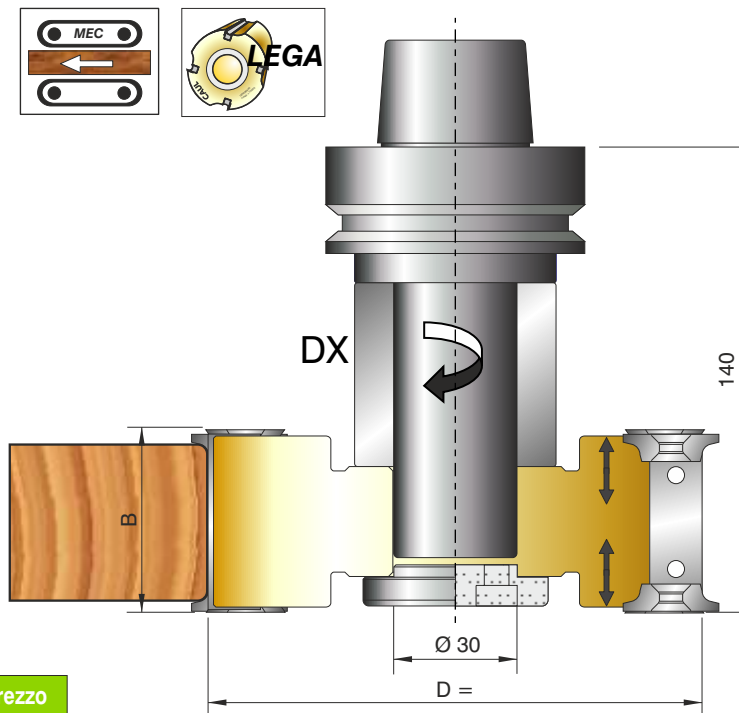
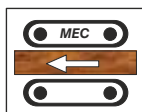

PE.02

Ø	n.min.	n.max.
125		9400



Articolo	D	B	Attacco	Z	R	S	↺ ↻	Prezzo
PE. 02.01	125	50	HSK 63F	2	4	4	DX	U 35
PE. 02.02	125	50	ISO 30	2	4	4	DX	U 36

RICAMBI-SPARE PARTS-RECHANGES-ERSATZTEILE-RECAMBIOS

Articolo	Descrizione	Dimensione	Prezzo
S0. CH.50	 Coltello / Knife	50x12x1.5	B35
CU. TB.10	 Cuneo / Wedge	50x12x10	A1
VU. DS.03	 Vite / Screw	M8x22	A45
VU. OC.02	 Ogiva / Nut	M8	A46
SC. CM.03	 Chiave / Allen Key	B4	A27
S4. RT.01	 Rasante / Shavers	22.86x2.5	E19
VU. RB.02	 Vite / Screw	M5x8	G42
SC. CT.03	 Chiave / Allen Key	T20	A30
S7. SB.05	 Spigolatori / Chanfering	26.8x15.8 R3	F23
S7. SB.06	 Spigolatori / Chanfering	26.8x15.8 R3	F23
VU. VS.02	 Vite / Screw	M6x15	A44
S7. PM.01	 Supporti / Supports	Tipo A	A4
VU. GC.06	 Vite / Screw	M6x16	A37
SC. CM.02	 Chiave / Allen Key	B 3	A27

Fresa con 2 taglienti, 4 incisori e 4 levaspighi (In fase di ordinazione eseguito lo spigolo richiesto, 45° R1.5 R3 R4.5), per eseguire battute e contornature con smussatura degli spigoli.

Cutters with 2 cutting edges, 4 scribes and 4 corner (When ordering, please specify desired profile, 45° R1.5 R3 R4.5) at radius, for making rabbets and profiles chamfering.



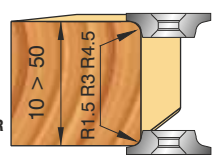
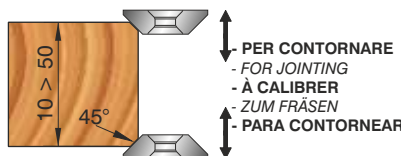
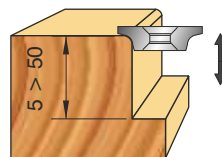
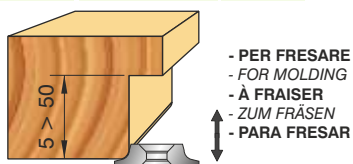

Fraise à 2 tranchants, 4 dents arasantes et 4 supprimeangles (Lors de la commande, il est nécessaire de préciser le profil, 45° R1.5 R3 R4.5), pour réaliser des pevilures et des contours avec arrondissement des angles.

Fraeser mit 2 Schneiden, 4 Graveuren und 4 Entkantern (Im Falle eines Auftrags bitten wir, das gewünschte profil, 45° R1.5 R3 R4.5), zur Herstellung von Anschlaegen und Konturbearbeitung mit Abfasung der Kanten.

Fresa con 2 cortes, 4 incisores y 4 "achaflanadores (Al realizar un pedido por favor especificar perfil, 45° R1.5 R3 R4.5), para seguir el galce y contornear con la inclinación de los achaflanadores.



PUNTA CNC PER TELAI DI PORTE

-  - CNC ROUTER CUTTER FOR SQUARING DOORS
-  - CNC MÈCHES POUR ÉQUARISSAGE DES PORTES
-  - CNC FRAESERGRUPPEN FUER TUERBESCHLAGUNG
-  - CNC BROCAS PARA LA ESCUADRERÍA DE LAS PUERTAS

PE.03

Ø	n.min.	n.max.
144		8700

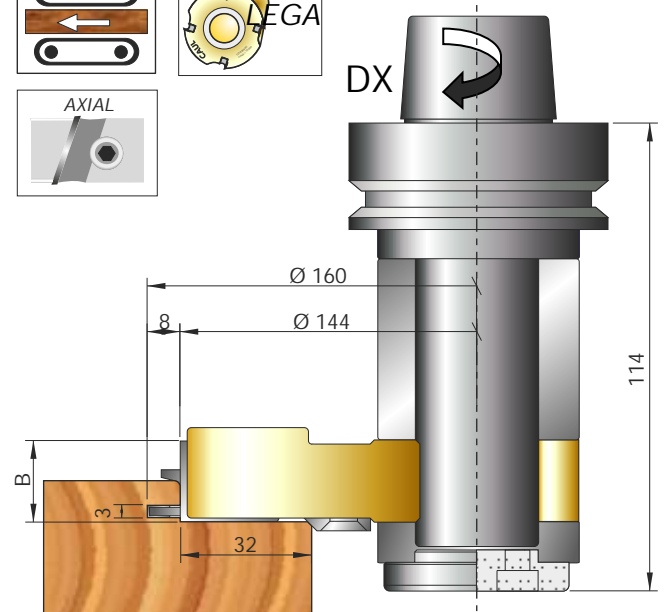
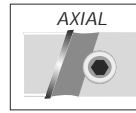
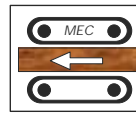

Articolo	D	B	Attacco	Z	↶	↷	Prezzo
PE. 03.01	144	25	HSK 63F	2	DX		U 37
PE. 03.02	144	25	ISO 30	2	DX		U 38

RICAMBI-SPARE PARTS-RECHANGES-ERSATZTEILE-RECAMBIOS

Articolo	Descrizione	Dimensione	Prezzo
CU. 04400PD01	 Cuneo / Wedge	20x25x10 DX	H9
VU. DS.03	 Vite / Screw	M8x22	A45
VU. OP.01	 Ogiva / Nut	M8	A47
S5. SB.03	 Settore / Sectors	25x20x3	F1
S7. 00001DSI01	 Spigolatori / Chanfering	17.6x16x5 45°	L13
S7. SB.03	 Spigolatori / Chanfering	26.8x15.8 R1.5	F22
VU. VS.02	 Vite / Screw	M6x15	A44
SC. CM.03	 Chiave / Allen Key	B4	A27

L'utensile esegue contemporaneamente la profilatura e la sede per la guarnizione.

The tool executes at the same time the profiling and the weather strip groove.



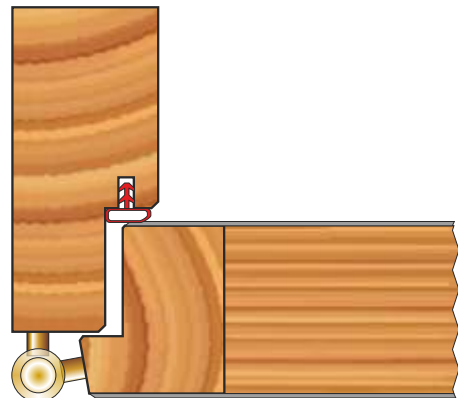

Le porte-outils exécute en même temps le profilage et l'entaillage du logement pour la garniture.

Das Werkzeug führt das Profil und zugleich auch den Sitz für die Dichtung.

La herramienta hace contemporaneamente el perfilado y la ranura para la goma.



IL LAVORO LA NOSTRA PASSIONE

-  - *WORK OUR PASSION*
-  - *TRAVAILLER NOTRE PASSION*
-  - *ARBEIT UNSERE LEIDENSCHAFT*
-  - *TRABAJAR NUESTRA PASIÓN*

